

CONTROLLING THE TEMPERATURE

Inside Equipment Enclosures



OBJECTIVE of this Whitepaper

The objective of this whitepaper is to provide the information and tools required to design effective thermal management for different types of AV systems. This whitepaper addresses 3 key considerations when designing an effective AV system:

- The components, and how they breathe (front intake, rear intake, side intake)
- The equipment enclosure, and how air flows (which is sometimes a piece of furniture, or mounted in a plenum or a wall)
- The room, and the considerations that must be made to ensure that the room can provide the correct temperature air and exhaust the heated air

The concepts provided in this guide provide the information and tools needed to calculate and understand when to vent an equipment enclosure using natural convection, and when it is appropriate to force the air (using fans). From this understanding, you will be able to provide the necessary information for the HVAC system to support the AV equipment installed.

Calculations and concepts described in this whitepaper are designed to maintain equipment at 85°F maximum temperature per the AVIXA F502.01:201X Rack Building standard.

Copyright© 2018 Middle Atlantic Products, a Brand of Legrand ("Middle Atlantic Products"). All rights reserved. All original information, logos, charts, graphics, images, and/or nomographs herein are the sole property of Middle Atlantic Products.

Warning: Unauthorized reproduction, copying, display or revision of this reference guide, or the information, charts, images and content of the reference guide, is prohibited by federal law and is subject to federal prosecution. Middle Atlantic Products gives the viewer of this Reference Guide a limited non exclusive license to view or print this publication. All uses of this Reference Guide must be for non-commercial purposes. The Reference Guide may not be copied or distributed without first obtaining the written permission of Middle Atlantic Products.

This Reference Guide is provided to the user for informational purposes only. Middle Atlantic Products makes NO WARRANTIES of any kind with regard to this document, including liability for system failure due to individual thermal management design. The Reference Guide is provided "AS IS" WITHOUT WARRANTY OF ANY KIND, EITHER EXPRESSED OR IMPLIED, INCLUDING, BUT NOT LIMITED TO, THE IMPLIED WARRANTIES OF MERCHANTABILITY, FITNESS FOR A PARTICULAR PURPOSE, OR NON-INFRINGEMENT. Some jurisdictions do not allow the exclusion of implied warranties, so the above exclusion may not apply to you. Middle Atlantic Products shall not be held liable for any damage, direct or indirect, actual or consequential, that may occur as a result of relying upon, using, following, or circumstances arising out of or in connection with this publication, or information provided, or referenced herein. Middle Atlantic Products, nor its officers, directors, employees, contributors nor agents shall be held responsible for any errors or omissions in this Reference Guide. Information in this publication is subject to update or change without notice at any time. References to other companies, their products or services, are provided without ANY WARRANTY OF ANY KIND, EITHER EXPRESSED OR IMPLIED.

Nothing contained in this Reference Guide should be construed as granting any right or license to use, reproduce, transmit, perform, publish, license, modify, rewrite, create derivative works from, transfer, store, or sell the content. This publication may be accessed by users internationally and may contain references to products or services that are not available in your country. These references do not imply that Middle Atlantic Products intends to, or will make, such products and/or services available in your country.

HVAC systems need to be engineered to meet the needs of the room. The HVAC system must be properly sized to accommodate the heat load generated by AV and IT equipment. In some cases, the HVAC system must maintain a low background noise level when operating. The objective there is to maintain the room's environment for safe equipment operating temperatures and noise-free acoustics, where low ambient sound levels are important. Heat loads, background noise specifications and ventilation requirements must be addressed very early with the HVAC designer/installer to ensure they are included with the design.

When fans are the choice, you will be able to calculate the required amount of airflow (CFM), and where to place the vents.

Fan choices, filtering and environmental variables are discussed, along with a range of real-world application diagrams and helpful charts on how proper thermal management can be achieved.

TABLE of Contents

OBJECTIVES OF THIS WHITEPAPER	1
DEFINITIONS	3
THERMAL MANAGEMENT - A SYSTEMS APPROACH	4
COMPONENT AIRFLOW, ENCLOSURE DESIGNS AND RADIATED DISSIPATION	5
PLANNING AIRFLOW INSIDE THE ENCLOSURE	6
PLANNING AIRFLOW: PASSIVE (CONVENTION)	7
PLANNING AIRFLOW: FORCED AIR (ACTIVE THERMAL MANAGEMENT)	8
FILTERS AND PRESSURIZED ENCLOSURES	9
HEAT EXCHANGERS & AIR CONDITIONING UNITS	10
PLANNING FOR THERMAL MANAGEMENT FOR CPU BASED DIGITAL DEVICES INCLUDING NVRS AND DVRS	11
ENCLOSURE PLACEMENT	12
RAISED FLOORS	13
PLANNING AIRFLOW INSIDE THE ENCLASURE	14
HOW TO CALCULATE VENTILATION REQUIRED	15
FAN LIFE AND FANS (FORCED AIR)	16
VENT SIZING FOR FORCED AIR (FANS)	17
AIRFLOW OBSTRUCTIONS AND AIRFLOW RATE & STATIC PRESSURE	17
VENTS, FANS, EQUIPMENT LAYOUT AND THERMAL SOLUTIONS	18
FUTURE PLANNING AND STANDARDS	19
REFERENCES	20



Controlling the Temperature

INSIDE EQUIPMENT ENCLOSURES

DEFINITIONS

/Formulas

- D** CFM - Cubic feet per minute, of airflow
- F** One "Ton" of air conditioning = 400 CFM (on most units)
- D** BTU/Hr. - British thermal units per hour, of heat
- F** 12,000 BTU/Hr. = 1 "Ton" of air conditioning
- F** One Watt of current draw (Volts X Amps) = 3.413 BTU/Hr.
- D** Frictional losses - the loss of pressure as air passes over materials - the rougher the material the greater the frictional loss. This is also referred to as impedance.
- D** Power Factor - measure of how effectively electricity is being used
- D** Rack - Enclosure, cabinet, or furniture for housing electronic equipment
- D** Room Load Capacity - The point at which the equipment heat load in the room no longer allows the equipment to operate within the specified temperature requirements
- D** HVAC - Heating, ventilation, air-conditioning
- D** Measured Power - Actual current draw measured by an ammeter to determine waste heat
- D** Nameplate Rating - A power, voltage and frequency rating used for regulatory approval [should not be exclusively used for waste heat calculations]



Maintaining the temperature inside enclosures is critical to the proper functioning and survival of the components operating within them. The best way to control this temperature is to take a systems (integrated) approach to thermal management.

Thermal design of equipment racks and enclosures is essential to ensuring the functionality of the equipment and system when subjected to the surrounding environment.

Heat has been proven to substantially reduce the service life of most equipment, which makes it vital to engineer the removal of this heat.

All components in the system must be reviewed - if one is found with a lower maximum operating temperature than this will be the new maximum recommended operating temperature.

Both the performance reliability and life expectancy of electrical equipment are inversely related to the component temperature of the equipment.

85°F is the maximum recommended constant operating temperature for most equipment; it will help provide a long service life for the equipment inside an enclosure.

Thermal Management USING A SYSTEMS APPROACH

Equipment

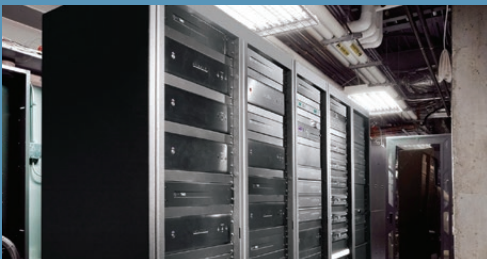

In most integrated audio/video installations, the largest heat load will come from power amplifiers, control systems and matrix switchers with onboard processing and scaling while they are driven. In addition, there are an increasing amount of small digital devices that produce a considerable amount of heat. Microprocessors, which are often embedded to do signal processing, emit greater heat from equipment than ever before.

Additionally, as the speed of microprocessors increases, the heat output rises proportionally. As a result more heat is generated per rackspace of equipment, leading to a greater heat density within the enclosure.

Other components like Class A and A/B Analog amplifiers can operate at far hotter temperatures; many operate well (with reduced thermal headroom) at 110°F! However, at elevated temperatures, computers & networking equipment fail more frequently than analog A/V equipment. With the continued integration of computer equipment and digital A/V equipment, more care needs to be taken when approaching thermal planning.

Where conditioned space is at a premium, amplifier enclosures should be separated from digital audio/video enclosures.



There are three airflows that must be considered; first is how the component exhausts heat. Next is how this heat enters, travels through and then exits the enclosure. Finally, how the air moves throughout the room and is ultimately removed. The interactions between these airflows are important, and must be considered when taking a systems approach.

There are some basic concepts to remember when designing a thermal management system. The first is that heat rises, which is called convection. When possible, utilizing convection is always preferred as it is more efficient. The second is that the goal is to remove the hot air generated by the equipment mounting within the enclosure, not to introduce colder air.

All heat (BTU/Hr.) generated by equipment must first be removed from the enclosure, and then the room itself must have the ability to remove the total heat from all enclosures. Many installations do not have the luxury of an air-conditioned environment, so consideration must be given to how the room itself will vent.

If the equipment room does not have the ability to remove the heat generated by the enclosure(s), then all of the following calculations will have little meaning. It is important to ensure that whatever heat is removed from the enclosure will not raise the room temperature significantly.

The cooler the room (as long as the room temperature is above the dew point so condensation does not occur), the fewer vents or fan CFM will be needed.

When designing any system, it is important to measure energy utilization – and find ways to reduce energy where possible.

For digital equipment, the room itself should be no hotter than 75°F. This gives a 10°F temperature difference between the room and the recommended 85°F internal enclosure temperature for optimum equipment life.

Remote monitoring solutions often provide the capability to measure utilization, in addition to temperature measurements, so potential issues can be addressed proactively before any equipment failures.

Enclosure DESIGNS

COMPONENT

Airflow

Equipment with front air intakes and rear exhaust require adequate airflow in the front of the enclosure. In these instances, the recommendation is for no front door, or as an alternative where security or aesthetics are a concern, vented front doors (at least 64% open area) should be utilized.

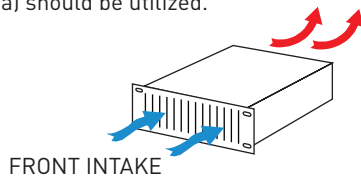

Devices with rear intakes and front exhaust must also be accounted for. In these instances there must be a way for air to come in from the rear of the enclosure and then vented from the front – either no door, or a vented front door (at least 64% open area) is recommended.

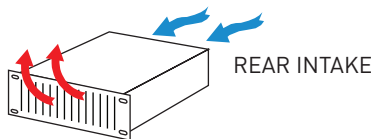

Components that have air intakes and/or exhausts on the sides, including many switches, require additional consideration to ensure proper thermal management. Wider enclosures provide more area for air to flow into the side which can then be routed via an air dam to exhaust through the rear. Additional consideration for multi-enclosure installations is also required to ensure that hot air does not travel from one enclosure to another. In these cases air dams, which are sometimes in the form of between-rack side panels, are effective.

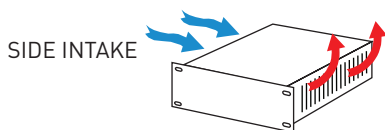

Many systems may have a mix of front, rear and side intakes and exhausts. In these cases thoughtful planning to ensure that hot exhaust air does not feed into the intakes of other components is required to ensure system longevity.



For passive convection (no fan) applications, wider enclosures are beneficial. A convective “chimney effect” is made possible by the space between the sides of mounted equipment and the enclosure’s sides. The presence of this space facilitates the drawing of heat upward.

In active ventilation (forced-air) applications, a narrower enclosure can be selected to save floor space. In this case, the best way to exhaust the air is to incorporate a fan top.

An enclosure without venting built-in to the top face should be selected when top-mount fans are required. Some enclosure manufacturers do not take proper thermal engineering into consideration, so care should be given to the enclosure selection process.

**PROPER
WIDER IS BETTER**
for side chimney effect on
front-intake equipment



narrow enclosures can save floor space in actively ventilated systems

enclosures with a wide footprint are ideal for achieving a chimney effect



airflow out equipment sides not “choked”

Radiated Dissipation

Non-vented solid areas of all steel enclosures dissipate internal heat to the outside by radiation. As the internal temperature rises, so does the temperature of the sheet metal enclosure. This heat is then radiated to the ambient environment. It is important to note that since wood is an insulator, equipment mounted within wood enclosures and furniture will not benefit from radiated dissipation.

This paper covers only passive convective venting and forced-air cooling, where the dissipated heat by radiation is negligible in the calculations of these scenarios.

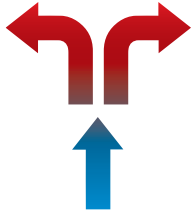

Planning Airflow

INSIDE THE ENCLOSURE

BEST ENCLOSURE

Airflow Methods

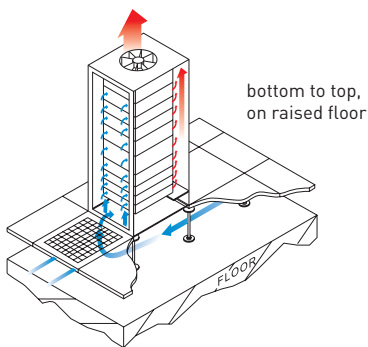
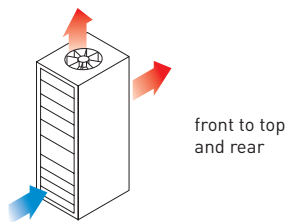
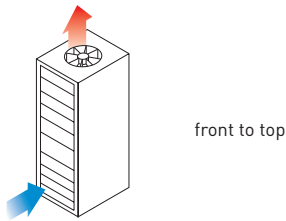
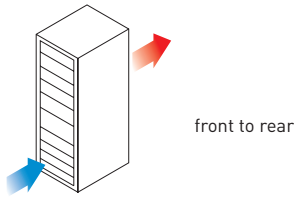

Systems mounted in enclosures should follow this protocol for best operation. The recommended airflow protocols for equipment follow closely those recommended in Telcordia GR-3028-CORE.



Proper planning of the cooling air path inside an enclosure ensures that no hot-spots occur, and that the waste heat is effectively removed. After you have reviewed this whitepaper you will see that most of the concepts provided are fairly straightforward to plan and implement. In the real world there are challenges presented by the different types enclosure-mounted equipment airflow, and how to integrate them into a single enclosure successfully.

By understanding these different types of equipment airflow, you will be able to properly plan the design of the enclosure to ensure that the hot air rises and exhausts from the enclosure as desired. There is some equipment that has internal fans that draw air in through the rear (or sides), and exhaust out the sides (or rear). This re-circulates the cabinet air and care should be taken as to its placement so the natural convective rise of heat is not disturbed. In forced-air enclosures (using fans to exhaust the heat) this is moot.

The most common airflow found in almost all equipment is that which pulls cooler air in from the front, and exhausts the heated air towards the rear or sides (known in this paper as front-intake equipment).

There are a few amplifier manufacturers who take the cabinet air through the rear and exhaust it out the front (known as "rear-intake" equipment). This presents some special thermal design challenges, as it does not allow hot air to exit the top of the enclosure. The fans in the enclosure top must push the air down when using this type of amplifier.

Some network equipment will pull air from one side to another, which is typically called side breathing. This isn't often found in an AV enclosure, but when it is special attention must be paid to ensure that adequate airflow is provided.

Downward airflows can be less than ideal, creating "mixed convection" (mixture of forced air and convection) during operation and in the event of fan failure. However, with proper application of thermal design principles these systems can function without issue.

Simulations and real-world testing show that moving air through a cabinet from bottom to top results in the lowest internal cabinet temperatures by taking advantage of convection.

PASSIVE

Thermal Management:

In this example, amplifiers with front intakes recirculate air because there are vents between the components.

WRONG PASSIVE CONVECTION

with front-intakes on equipment

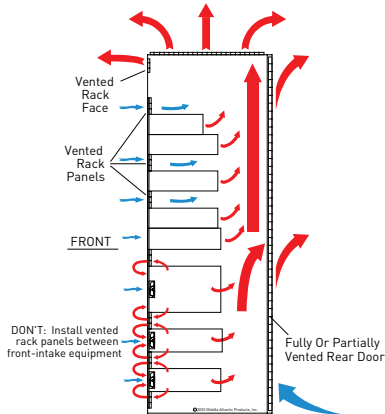

SIDE VIEW

PROPER PASSIVE CONVECTION

with front-intakes on equipment

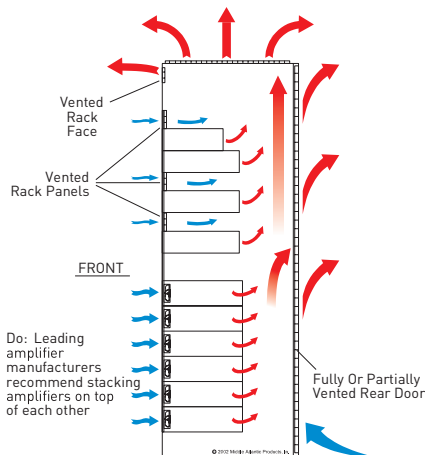

SIDE VIEW

A fully vented rear door allows hotter air to escape the enclosure more effectively.

PROPER PLACEMENT OF VENTS

when amplifiers are NOT fan cooled

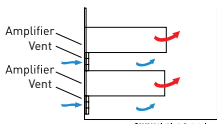

Hot air rises while cold air falls. The hotter it gets, the more CFM flow occur by natural convection. The friction of all vents gets in the way of the flow; more open area, in the form of slots or perforations, is always better. For multiple convection-cooled amplifiers, put vents in between, unless the amplifier manufacturer states otherwise.

Planning Airflow

PASSIVE (CONVECTION)



In an environment at normal room temperature, an enclosure is able to dissipate 300 to 500 watts of heat (not "audio" watts) through natural convection. This requires adequate vent openings at the bottom and top of the enclosure (none in the middle for effective "chimney" flow), and unimpeded airflow inside. The main advantage of natural convection is its intrinsic reliability. Air movement in a properly configured cabinet is generated by thermal gradients. Proper configuration most importantly includes optimization of component placement. Hotter equipment located lower in the enclosure will provide a greater natural airflow.

When using passive convection in high ambient temperatures (approximately 90°F and higher), the components that generate the most heat should be placed near the top of the cabinet, except when loaded enclosures are transported to job sites, or in a seismic installation. Calculating airflows in a passive convection enclosure is complicated. The slow speed of airflow makes it nearly impossible to measure, and smoke tests show air can enter and exit from the same vent.

Equipment that passively vents (without fans) sometimes has intake vents on the bottom, or vents on the top, so care must be taken not to block these with equipment stacked directly on top of each other. Otherwise, it is acceptable to stack equipment directly on top of each other.

Many times installers simply put vents between each piece of equipment without regard to the re-circulation of hot air. This can "short-circuit" the airflow because the vents are placed too close to fans or heat sources. Good airflow strategies break the temperature stratification areas, which cause "hot-spots". In some cases the re-arrangement of vents and equipment is required. For equipment with front-intake, it is perfectly acceptable to save enclosure space by stacking equipment directly on top of each other as long as this equipment has no vents on the top or bottom of its chassis.

The diagrams (to the left) show this arrangement with passive convection. As with any passive convection scheme, the more venting up top and on the bottom, the better. Choose enclosures that have vents built into the top and bottom face for optimum performance, and ensure that a fully vented top option has been installed.

Installing a vented rear door in a passive cooling scenario is not necessarily required; this is dependent on the total BTU/Hr. produced within the enclosure. For clarification, consult the nomograph on page #15.

It is important to note how the passive convection scheme changes, with front-intakes on equipment (fans inside the amplifier, for example) and without fans built in.

Planning Airflow

FORCED AIR (ACTIVE THERMAL MANAGEMENT)

ACTIVE

Thermal Management:

Common Mistake vs. Simple Solution

Example of airflow recirculation

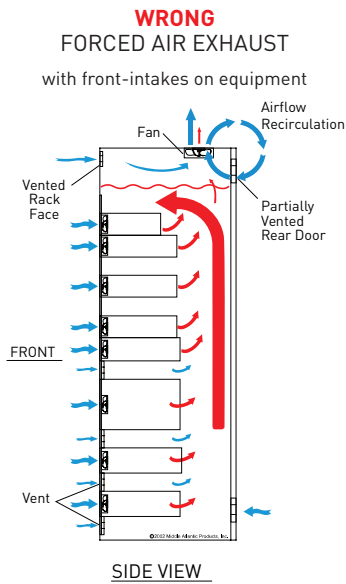

Problem: Fans draw cooler air from the top enclosure openings instead of drawing heated air from the enclosure itself.

Solution: Keep inlet and exhaust air far apart. Avoid vented panels in upper 15% of enclosure

PROPER
FORCED AIR EXHAUST
with front-intakes on equipment

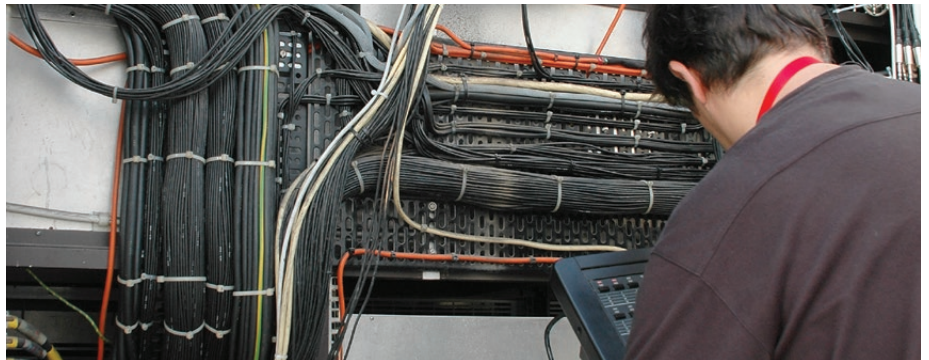
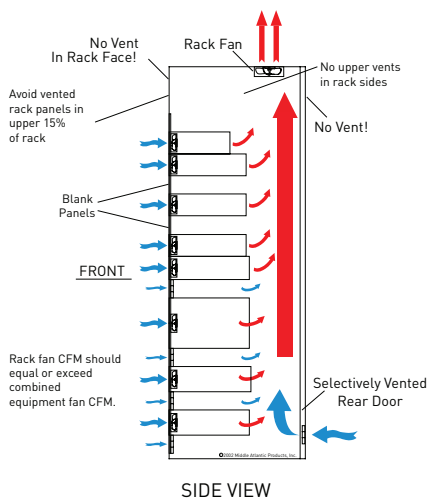

When there are too many BTU/Hr. for natural convection to adequately remove heat, it is essential to force the heated air from the enclosure. Active thermal management involves the use of fans to effectively remove heat from an equipment enclosure.

Most front-intake equipment fans are between 25 and 50 CFM each. If a fan is required for the top of the enclosure, ensure that this fan's CFM rating is at least the sum of the CFM ratings of all the equipment fans. When this is followed, hot air will not "short-circuit" and re-circulate between equipment, as the fan will draw air from all openings. A solid rear door with a vent on the bottom is recommended in this situation to control airflow from front to rear. Where forced air is required, it is acceptable (but not essential) to put vents between equipment with front-intakes. It is important to note that fan CFM is a maximum rating, as if you mounted it in free air. As soon as you connect it to an enclosure, the flow rate decreases because of air friction.

Note that the "Proper Forced Air Exhaust With Front-Intakes on Equipment" diagram shows no vents in the upper enclosure face, no vents in the upper rear door, and no vents in the upper 15% of the enclosure. This will prevent the "short-circuiting" of air at the top of the enclosure.

PROPER
FORCED AIR EXHAUST
amplifier placement in hot ambient areas with fans

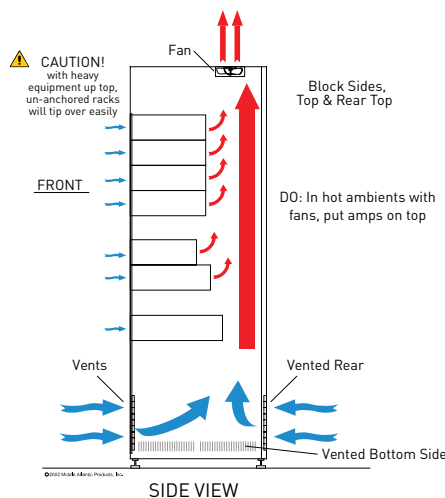

PROPER
FORCED AIR EXHAUST
with fans mounted in rear door, smaller systems

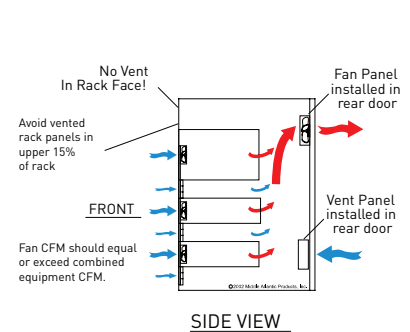

Planning Airflow

FORCED AIR: FILTERED

Filters



Filtering helps protect digital and other sensitive equipment from “hygroscopic dust failure”, which occurs in humid environments (generally 65% relative humidity or higher). Dust absorbs moisture and deposits itself on circuit boards. Computers and other digital equipment utilizing rapid microprocessor clock rates will be most affected by this hygroscopic dust failure.

Many manufacturers sell washable filter kits that can be mounted over fans or used as a filtered vent panel to protect equipment from the hazards of hygroscopic dust failure.

Filter loading and subsequent maintenance requirements can be greatly reduced with the use of a proportional speed thermostatic fan control circuit, since the overall volume of air is lower when not required.

Good filters should have a long service life, low static pressure drop and should be washable. **Filters require maintenance or they will clog!** Filters that are extremely dirty act like blank panels, and will dangerously elevate enclosure temperatures. Do not use filters unless an effective maintenance process is in place.

A heat exchanger is a better solution for keeping contaminants out of the enclosure in very dusty environments or when maintenance is questionable.

PROPER FORCED AIR FILTERED, EXHAUST

without front-intakes on equipment

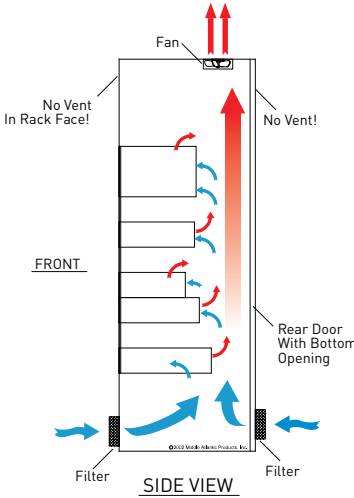

PROPER FORCED AIR FILTERED, EXHAUST

with & without front-intakes on equipment

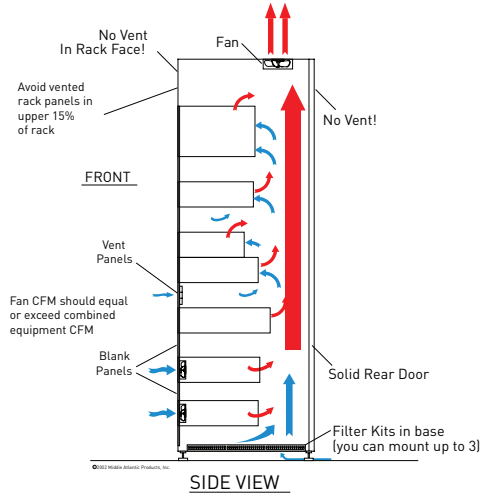

Pressurizing Enclosures

The best solution for dusty or dirty environments where filters will need to be changed regularly is to pressurize the enclosure, rather than sucking the air out of the top.

Although less thermally efficient, pressurizing guarantees that clean air escapes through cracks and openings, rather than allowing dirty air to enter.

PROPER FORCED AIR PRESSURIZING, EXHAUST

without front-intakes on equipment

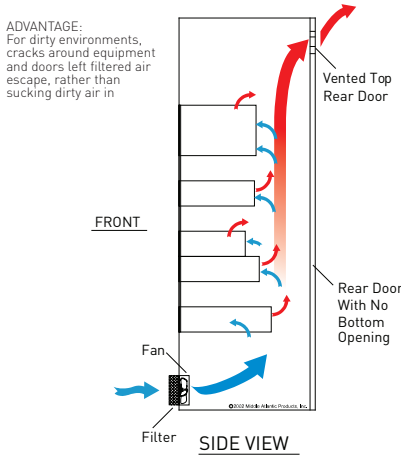

ADVANTAGE: For dirty environments, cracks around equipment and doors left filtered air escape, rather than sucking dirty air in

Planning Airflow

HEAT EXCHANGERS & AIR CONDITIONING UNITS

In the first example, air is being pushed down to equipment with a rear fan intake. This is most effective when there is a cold air duct above the enclosure. For this to be effective, the fan must push enough air to overcome the combined forces of convection and friction, as well as the exhaust fans mounted within the components. If the fan is not strong enough to do this then the system will not work effectively.

PROPER FORCED AIR - PRESSURIZING with rear equipment fan intake

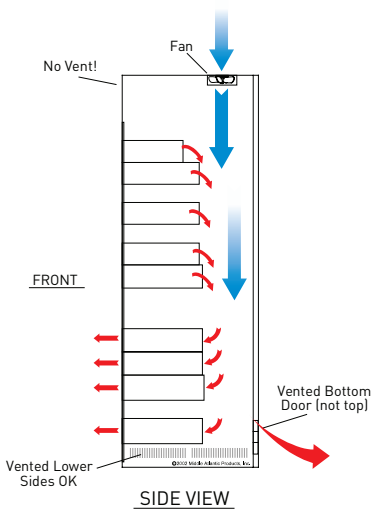

In the second example, the fan does not move enough CFM to adequately meet the needs of the system. As a result, the outside air does not make it far enough down the enclosure to cool the lower components with rear mounted intakes.

WRONG FORCED AIR - PRESSURIZING

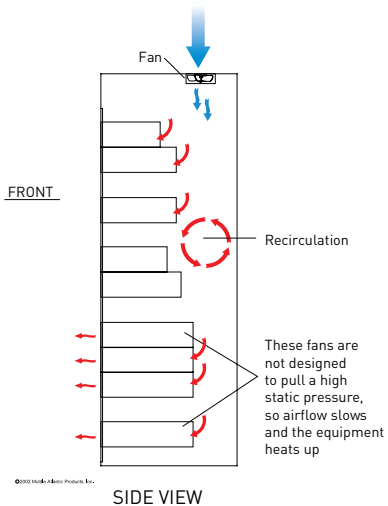

In very harsh environments such as dirty factory floors, filters quickly become clogged and heat inside the enclosure builds rapidly. In these applications, NEMA (National Electrical Manufacturers Association) rated enclosures that are gasketed and sealed should be installed.

Heat exchangers and air conditioning units (mostly installed in NEMA rated enclosures) do not allow the ambient dirty air to mix with the enclosure interior air, which ensures that the interior enclosure air stays clean.

These devices (either water-coil or refrigerant-compressed) are also the only way to make the temperature inside the enclosure cooler than the ambient air. Care should be taken to avoid condensation when cooling the enclosure with an air conditioning unit. The dangers of condensation from cool air are overcome by ensuring the air temperature is above the dew point.

PROPER SIMPLIFIED HEAT EXCHANGERS AND AIR CONDITIONERS

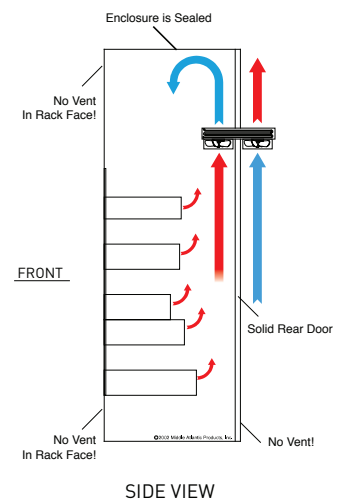

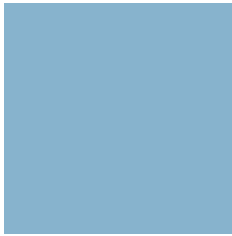

Planning Airflow

THERMALLY DENSE SYSTEMS

In FURNITURE

When mounting components in furniture, it is critical to ensure there is a pathway for air to enter from under the front door (this intake area should be equal to or greater than the opening of the exhaust fan), and then to exhaust from the top.

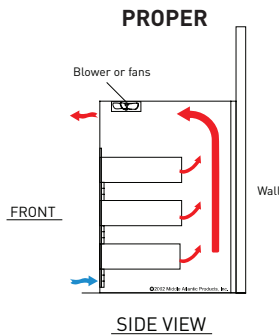

In this instance, there is a quiet blower mounted in the top to exhaust the heat from the front. If there is no active front exhaust then it is critical that there is a gap between the furniture and the wall to ensure the heat has a method to escape.

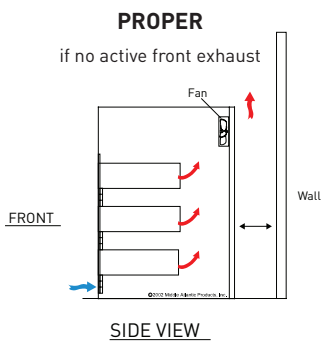

FOR DENSE INTEGRATION OF CPU BASED DIGITAL DEVICES INCLUDING NVRs AND DVRs

The most common airflow found in most CPU based devices including servers, control systems, networking, digital video recorders (DVRs), network video recorders (NVRs) and higher current draw equipment is that which pulls cooler air in from the front with the aid of front-intake fans, and exhausts the heated air towards the rear or sides (known in this paper as "front-intake" equipment). Effective thermal planning for NVR or DVR equipment cabinets involves the use of large perforated front & rear doors that ensure 64% minimum open area for adequate airflow into and out of the cabinet.

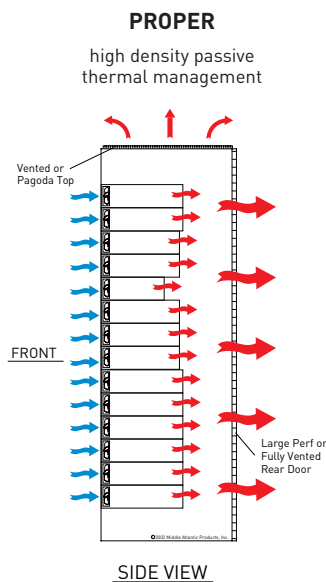
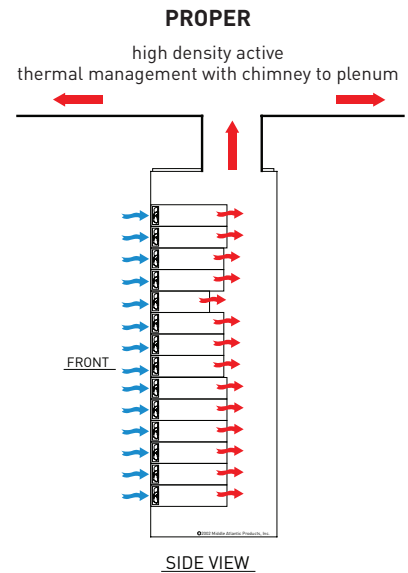
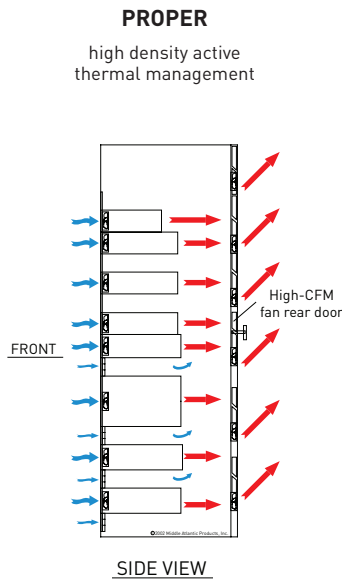



Planning Airflow

ENCLOSURE PLACEMENT



Heat flows from hot to cold and you cannot make the heat come out of a cabinet unless the outside air is cooler. Convection is the process of air passing over a hot object and carrying the heat away.

It is always better to focus on removing heat from above, rather than adding cold air where possible.

In quiet office environments where equipment is housed in enclosures in closets, fan noise is often not welcome. Ambient temperature can be higher in closets, and heat should be exhausted out if the ambient air inside the closet exceeds 75°F. In the case of a single enclosure in a closet, it is important to use a fully louvered closet door and monitor the temperature when there is no active ventilation in the closet. If natural convection is not adequate to maintain 75°F a thermostatic exhaust fan needs to be installed.

Enclosures that are mounted in non-traditional place such as in ceilings, walls, plenum spaces and furniture are increasing. In these cases extra attention must be paid to ensure that adequate airflow is present – otherwise thermostatic exhaust fans will be required.

In the case of equipment enclosures in an air-conditioned room (without a raised computer floor), it is better to have the supply ducts and diffusers in front of the enclosures, and the return ductwork and registers in the rear of the room. For enclosures in data centers, the ASHRAE Guidelines recommend a maximum inlet temperature of 80.6°F.

Avoid locating the enclosures directly under supply ductwork. Cold air falls, and the flow of the hot air that rises from the top of the enclosure should have no impediments on its way back to the return air (intake) duct.

PROPER ENCLOSURE PLACEMENT

in relation to air conditioning airflow

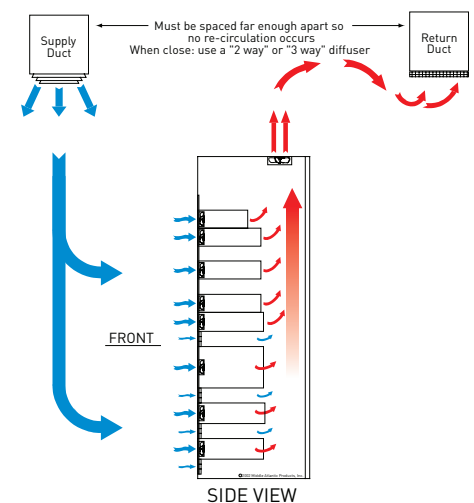



Planning Airflow

RAISED FLOORS



There are many strategies for introducing cool air into enclosures while on a raised floor. One provides an air outlet grate in front of the enclosure, and another is to have the air enter through the bottom of the enclosure. Both methods work well, as long as proper airflow is engineered into the system, ensuring adequate air is provided to the intakes of equipment. However, floor grates in front are recommended.

The downside to a totally perforated cabinet with cold air-cooling in a raised floor environment is uneven cooling and short-circuiting of airflow. If the air is too cold, condensation can occur, and energy costs for the facility will be high.

Most industry experts agree that the optimum layout for high heat density enclosures is an arrangement in rows of two, to produce hot and cold aisles. The fronts of the enclosures face each other in the cold aisle, with air grating down the center for cold air supply. The rear sides of the enclosures face each other in the hot aisles, with return grills overhead for optimum utilization of the air conditioning system. To maximize efficiency, a hot aisle containment system is often utilized. Hot-aisle containment allows for the exhaust heat to be removed while separating it from the cold air being introduced into the space.

PROPER THERMAL MANAGEMENT in a raised floor application

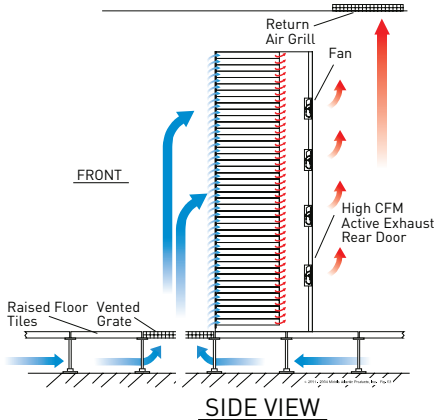
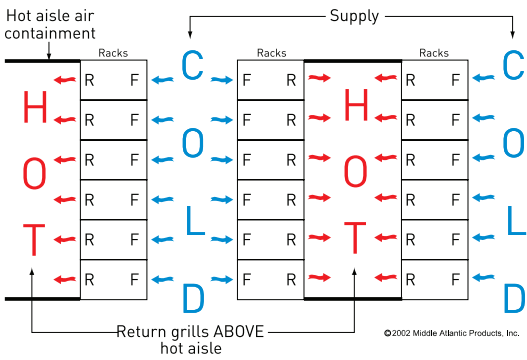

Amplifiers



Amplifiers are not as straightforward, due to the different nature of circuit designs and other variables. Taking into consideration which output design is found in the amplifier, the type of power supply, what type of program material is played, how many Ohms the speaker load is, and at what level the amplifier is to be driven on average, the real-world BTU/Hr. output can be estimated. Amplifiers are available in many design classes, which have varying degrees of efficiency. Class A, B, AB, and D are several examples.

At the low end of the thermal efficiency spectrum, Class A amplifiers average no more than 20% efficiency, which means 80% of the line current draw will be converted to waste heat. It is extremely rare to find this class of amplifier installed in banks of equipment enclosures. At the other end of the thermal efficiency spectrum (high thermal efficiency), Class D amplifiers have up to 90% of the power cord draw watts converted to useable output watts, which means they will only generate 10% waste heat. Class D amplifiers, however, work more efficiently under loads, and actually generate more heat at idle than when driven! As with class A, it is rare to see class D amplifiers used in larger jobs.

Class AB amplifiers are the most common; therefore this paper's associated charts and graphs are based on that class of circuitry. Although most amplifier manufacturers publish their class AB amps at 60% to 70% efficiency with sine waves, real-world program material measurements show that a more conservative realistic efficiency is 50%, and is the basis for all calculations found in this paper.

Several amplifier manufacturers recognize the importance of thermal planning, and publish excellent data on how much waste heat in BTU/Hr. are generated for varying loads and input material. It is highly recommended to obtain this heat loss (waste heat) information from the amplifier manufacturers. The proper calculations then can be derived with that information.

Planning Airflow INSIDE THE ENCLOSURE



When designing electronics systems, it is critical to ensure that not only can heat be removed adequately, but also that any thermal management system, whether passive or active, can handle the heat generated by the specific components being installed. Waste heat output will vary greatly between different types of equipment, therefore consideration must be given to the individual components as well as how they act as part of the whole system in each rack or enclosure.

Most equipment converts almost all of the power drawn into waste heat. Calculating BTU/Hr. output for most equipment is simple: the more current it draws, the more BTU/Hr. will be produced. At 117 volts, each ampere of current drawn produces exactly 400 BTU/Hr. of heat output.

Note: estimating BTU/Hr. for amplifiers requires different considerations; see Amplifier Calculations section.

Formula for conversion of current draw to BTU/HR:
One Watt (Volts X Amps) = 3.413 BTU/HR.

ACTUAL FINANCIAL INSTITUTION VIDEO COLLABORATION SYSTEM

EQUIPMENT	NAMEPLATE RATING*	ACTUAL MEASURED
CATV TUNER	0.16	
SOURCE COMPONENT/STREAMING DEVICE	0.13	
PRESENTATION SWITCHER	1.2	
VIDEO SCALER	0.3	
AUDIO MIXER	1.69	
VTC CODEC	2.3	
TRANSMITTER/VOLUME CONTROLLER	0.12	
CONTROL PROCESSOR	2.4	
4 CHANNEL AMPLIFIER	6.3	
75 W POWER SUPPLY	2.3	
TOTAL SYSTEM AMPS:	16.9	2.54
RESULTING IN BTU OUTPUT:	6760	1016
CFM REQUIRED** FOR OBTAINING 85°F EQUIPMENT TEMPERATURE	418	63

* Units with nameplate rating in watts have been converted to amps.
Total system power factor averaged .78
**In 70°F Room, actual (after frictional losses) airflow CFM, not fan manufacturers spec

Nameplate ratings should never be used as a sole measure of equipment heat release. The purpose of a nameplate rating is solely to indicate the maximum power draw for safety regulatory approval. In real-world tests, equipment nameplate ratings far exceeded actual current draw. The drawback of thermal management planning based solely on the nameplate ratings is that in many cases, the specified AC equipment will be oversized for the actual amount of heat released, resulting in wasted money and decreased operating efficiency.

The example (on left), illustrates just how different a typical system's actual measured amperage is, compared to the nameplate ratings of its equipment.

How to Calculate VENTILATION REQUIRED

Typical AMPLIFIER Manufacturer's Data

Model "X": 8 Ohm Stereo Mode, 16 Ohm Bridged Mono, or 4 Ohm Parallel Mono

PROGRAM MATERIAL	PROGRAM DUTY CYCLE	WASTE HEAT BTU/HR.	CURRENT DRAW 120VAC
INDIVIDUAL SPEECH	10%	390	1.6A
ACOUSTIC/CHAMBER MUSIC	20%	460	2.2A
FULL RANGE ROCK MUSIC	30%	540	2.9A
COMPRESSED ROCK MUSIC	40%	620	3.5A
PINK NOISE	50%	700	4.2A

Model "X": 70V Mode, Any Configuration

PROGRAM MATERIAL	PROGRAM DUTY CYCLE	WASTE HEAT BTU/HR.	CURRENT DRAW 120VAC
INDIVIDUAL SPEECH	10%	390	1.6A
ACOUSTIC/CHAMBER MUSIC	20%	480	2.3A
FULL RANGE ROCK MUSIC	30%	560	3.0A
COMPRESSED ROCK MUSIC	40%	640	3.7A
PINK NOISE	50%	720	4.4A

The information provided on this page is calculated data based on driving both channels to rated output.

Other parameters used in calculation include a conservative idle current estimate of 90 Watts and a conservative estimation of efficiency at 65%.

Information is provided for the purpose of getting an idea of current draw and heat produced. Actual performance will vary depending on environment, program material, load, signal, and AC mains voltage and frequency. Values of calculated current draw are intended to represent average draw corresponding to the thermal breaker requirements that should be met to handle the amplifier as a load on the AC mains. Peak current draw with dynamic program material may be significantly higher. Thermal information is provided to assist with calculating air conditioning needs. The above data should not be construed as specifications.

TO PROVIDE AN INTERIOR ENCLOSURE TEMPERATURE OF 85°F.

This nomograph will show the minimum ventilation (active or passive) required, to provide an interior enclosure temperature of 85°F. Amplifiers vary greatly in waste heat output. This nomograph should be used ONLY when waste heat data is available from the amplifier manufacturer or the total current draw has been measured under load. This is typically calculated at 1/4 or 1/8 power with pink or white noise generated.

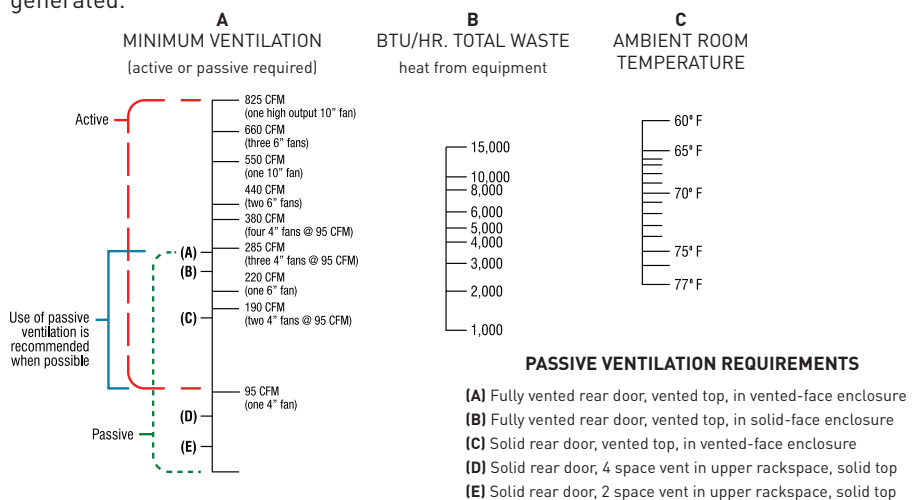

NOTE: Nomographic information provided is based upon calculations to determine CFM in ideal conditions. Real world applications may include conditions that result in air impingements including cable obstructions and may require additional considerations.

In general, to calculate the amount of CFM needed to cool an enclosure to a given temperature, the following formula may be used:

$$CFM = 9262 \cdot q / \Delta T$$

Where, q=amount of heat transferred, BTU/hr

ΔT =Temperature rise within the cabinet, (T_{IN}-T_{AMB}), F

TO CALCULATE TOTAL WASTE HEAT (COLUMN B):

1. Obtain total waste heat output by combining the published waste heat BTU/HR. of all amplifiers in the enclosure.	
2. Add up total measured amperage draw from all other equipment and multiply by 400 (total amperage x 400 = total BTU/HR. @117v.)	
Important Note: Nameplate ratings should at no time be used as a measure of equipment heat release. The purpose of nameplate rating is solely to indicate the maximum power draw for safety regulatory approval.	
3. Combine BTU/HR. totals from steps 1 and 2 to obtain total for all equipment. Mark total in column B.	

OBTAIN MINIMUM VENTILATION REQUIREMENTS:

1. Mark ambient room temperature in column C, and connect points in B and C with a straight-edge.
2. The minimum cooling required providing an interior enclosure temperature of 85°F will be shown on column A, where the straightedge intersects the minimum cooling requirements column.

OBTAIN MINIMUM VENTILATION REQUIREMENTS:

1. For passive and active ventilation, ensure adequate intake vents are installed.
2. Be certain no "short-circuiting" of air occurs (See earlier diagrams) .

Temperature should be measured from the highest available rearmost position within the rack.

Fan Life



All fans fail over time. Ball-bearing fans outlast sleeve-bearing fans by about 50%. At 90°F a ball-bearing fan will last approximately 55,000 hours, while a sleeve-bearing fan will quickly become inoperable at this temperature.

Both AC and DC fans are available. There are some significant benefits to DC fans – they are more efficient because they utilize less energy to operate, are quiet, and are more easily controlled. AC fans, on the other hand, are available in a wider variety of sizes and may be the only option when there is the need to move larger amounts of air.

Because of the necessary bearings inside fan assemblies, fans are more susceptible to failure than any other component. The most practical way to extend fan life is to use a proportional speed thermostatic fan control. These fan controls extend equipment life and reduce service calls by varying fan speed based upon temperature. A temperature probe triggers fans when an enclosure's internal temperature reaches a pre-set level. Another benefit of a variable speed fan controllers is that it utilizes less electricity.

The faster a fan runs, the faster it wears out. Fans with variable speed controllers are also "self-adaptive" - they take into account changes in ambient temperature and the varying power dissipated by equipment. As air is pulled through it inevitably brings dust, even when filters are utilized, therefore using a variable speed fan controller to limit airflow to only what is required brings an additional benefit beyond noise reduction and efficiency, a cleaner and more efficient system that will be easier to service.

Important note when using filters. Filters can become clogged quickly and require frequent cleaning to ensure the system does not become starved for air. The frequency for cleaning will depend upon the environment in which it is installed, along with the amount of air being drawn through the enclosure. In these case a remote monitoring system is also recommended to ensure that any system issues are quickly identified before failures occur.

Proper Utilization of FANS (FORCED AIR)



Fans will substantially reduce interior operating temperatures if intake vent placement, size, and airflow are done correctly.

Venting in the wrong locations can also cause "hot spots", where air does not flow. Proper fan/vent placement will force more air "disturbance" inside of a enclosure, breaking up these hot spots. The use of a fan tray can also remove hot spots.

Fans are only effective when the system is designed properly. It is critical to ensure that air intake points are close to the fan, and cooler air is brought in from the bottom portions of the enclosure.

Additionally, fans help reduce condensation in colder ambient environments. Condensation increases equipment downtime. The ideal spot for fan placement (unless it is a dirty environment) is in the top, where the hotter air needs to be removed. This also aids the natural force of the hot air rising. Enclosure mounting fans is recommended where there is a likelihood of contaminants falling into the enclosure from above.

Using multiple fans mounted next to each other requires that they be checked regularly for proper operation. Once one fan stops functioning, it provides a short-circuit path for the airflow. Don't be fooled by thinking the addition of redundant fans will help; when one fails, it acts as a vent near a fan and will not remove heat from the enclosure effectively. Regular systems checkups are critical to ensure fans are operating properly to avoid this re-circulation of heated enclosure air. Remote monitoring devices are a better method to ensure cooling systems are working effectively, and can help to identify issues before system performance and reliability are affected.

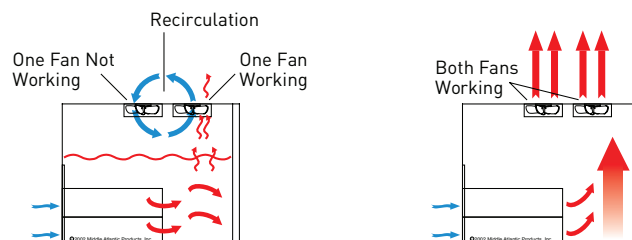

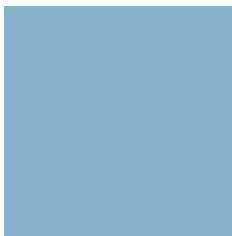

AIRFLOW Rate & Static Pressure

VENT SIZING For Forced Air (Fans)

To avoid “starving” the forced airflow, consideration must be given to provide adequate intake venting area. The following are minimum recommendations on the number of rackspaces of venting – more venting is better, if properly placed. See the diagrams elsewhere in this paper for where to put them, and where NOT to put them.

ASSUMPTIONS:

1. Rackmounted vents have 64% minimum open area
2. No equipment has front-intake (Less venting is required if “series” conditions are present from the front-intake fans in equipment)
3. 4” fans deliver 95 CFM
4. 4-1/2” DC fans deliver 69 CFM
5. 6” fans deliver 220 CFM
6. 10” fans deliver 550 CFM
7. H10” (High-output) fans deliver 825 CFM

FAN QTY	FAN SIZE	MINIMUM # OF VENTED RACKSPACES
1	4”/4-1/2”	2 spaces
2	4”/4-1/2”	3 spaces
3	4”/4-1/2”	4 spaces
4	4”/4-1/2”	5 spaces
1	6”	4 spaces
2	6”	5 spaces
3	6”	6 spaces
1	10”	6 spaces
1	H10”	8 spaces

If the rack has a vented rear door (Bottom-only is ideal for top mounted fans), less rackmount venting is required. Visual interpolation is adequate for approximating how many vented rackspaces are required in this situation. Please note that the overall vented area should not be less than specified in the above chart.

Two terms are used to describe fan performance: Airflow Rate and Static Pressure. Airflow rate is the volume of air moved per unit of time, commonly expressed as cubic feet of air per minute (CFM). Static pressure (S.P.) is the pressure or suction the fan is capable of developing. In an enclosure, it is the measurement of resistance to airflow.

There is system impedance involved with forced-air cooling. As air travels through intake vents and filters, the air pressure drops. The system impedance is the sum of all pressure drops. The fan selected must be capable of operating at this static pressure, or the CFM will drop.

All fans have performance curves, which show how much CFM will be delivered at various static pressures. All diagrams and fans referred to in this paper operate within the proper range.

By definition, a fan is an axial device in which the air moves straight through. A blower’s air intake is 90 degrees to the discharge outlet, and is not frequently used in an audio/video enclosure. Blowers also produce a greater static pressure than fans, and can provide more airflow in a smaller space. Blowers can also be very quiet when properly designed for AV systems, and when a proportional speed thermostatic fan control is employed.

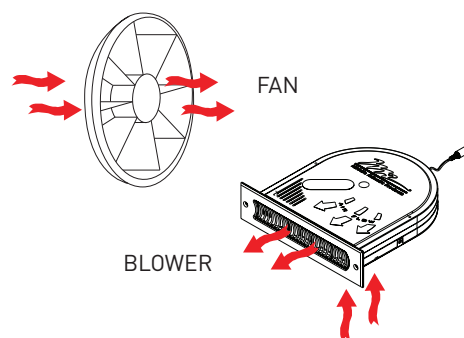

AIRFLOW Obstructions

Shelves can be an important component of the enclosure’s internal airflow planning process. Shelf surfaces that overhang the internal natural rise of heat should be vented.

Any obstruction to airflow will raise the temperature in the lower portion of the enclosure, possibly creating a stratification zone, and should be avoided if possible.

Large horizontal cable bundles, when not properly dressed, can also obstruct airflow.

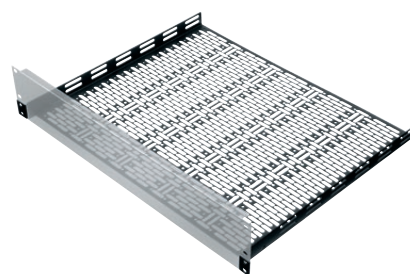

NOT ADVISED

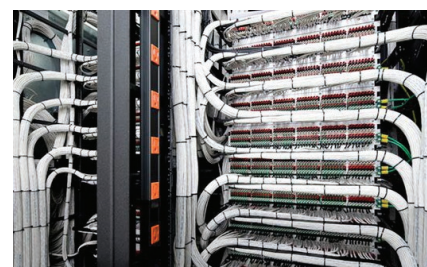

PROPER

Vent, Fans and Equipment Layout

The optimum configurations presented in this paper have been derived using both thermal modeling and actual temperature measurements.

The installation of front doors in most cases has an effect on airflow. A fully perforated front door (64% minimum open area) does not impede any fan's performance; the paths of air inside the enclosure and temperatures are not changed. A vented plexiglass front door's performance varies based on the design of the door, from inadequate to adequate.

As a general rule, if a vented front door with less than 64% open area is chosen, fans are recommended. The exception to this rule is when the equipment has high static pressure front-intake fans built in (which is rare).

In most other cases, the use of a fan in the top of the enclosure "in series" with the equipment's built-in fans will increase the static pressure (decrease the air system's impedance), so air can be "pulled" through the vented door more effectively. In this series arrangement, both the enclosure fan and equipment fans work together as a team, increasing the cooling effectiveness.

It is a common misconception that the equipment fan working in conjunction with an enclosure fan will increase the airflow. As you can see from the "Parallel vs. Series Fans" chart on the next page, this configuration provides greater static pressure. It does NOT increase the airflow. The only way to increase airflow is to add a fan in parallel, or obtain a fan with a greater CFM rating to exhaust air from the enclosure.

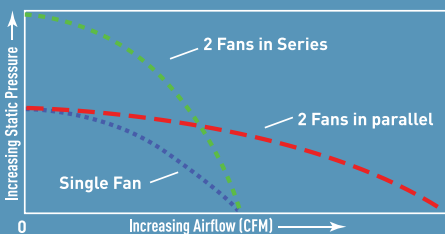
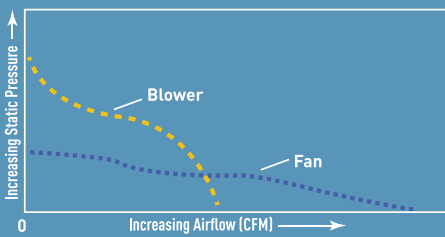

THERMAL Solutions



Fan Panels

Fan panels mount to the face of the enclosure and are available in AC and DC variants, and can be coupled with a thermostatic fan controller.



Rackmount Blowers

Rackmount blowers provide a higher static pressure and can provide more airflow in smaller spaces.

Fan Tray Systems

Rackmount fan tray systems allow the placement of fans directly above vents on equipment to help remove hot air, or to promote vertical airflow in the rear of the enclosures



Thermostatic Fan Controllers

Thermostatic fan controllers operate fans only when needed, extending fan life and reducing the amount of dust drawn into the enclosure.



Fan Tops

Fan tops mount to the top of the rack to exhaust heat. When possible, select one with an integrated fan controller.



Vent Blockers

Careful placement of vent blockers, as part of your thermal management system planning, will prevent the short-circuiting of airflow in enclosures. Magnetized on one side (only) to eliminate stray magnetic fields, vent blockers will ensure that heated enclosure air will be forced out through top-mounted exhaust fans.

High CFM Rear Doors

High CFM cupboard style split rear doors pull hot air from the rear of the cabinet and direct it up towards return air ducts.



STANDARDS

Some current standards relating to thermal management, heat release, and temperature requirements are found in the NEBS (Network Equipment Building Standards) series.

Telcordia GR-3028-CORE (Thermal management in telecommunications central offices) includes the results of advanced computer modeling techniques for thermal management.

ASHRAE TC9.9 provides guidelines for temperature and humidity for racks in data centers.

ANSI/INFOCOMM (AVIXA) 4:2012 Audiovisual Systems Energy Management standard provides guidelines to encourage sustainability by measuring and reducing energy usage.

AVIXA F502.01:2018 Rack Building for Audiovisual (AV) Systems provides overall system design detail, including thermal management requirements.



Courtesy of Peter M. Shipp Photography

The design of enclosures and thermal loading should take into account future expansion & changes. As stated earlier, the room needs to exhaust all the heat produced by the equipment, so it is important that the facility be able to handle future expansion.

Blank panels should be installed in all unused enclosure and cabinet spaces to maximize and improve the functionality of the controlled air system. Vented panels should be added to the front cabinet rails, if properly oriented (per diagrams contained within this document), thereby preventing the recirculation of hot air to the equipment inlet.

Many times when equipment is added to a enclosure, the effective thermal design is compromised. When this happens it is critical to review the design to ensure the internal enclosure temperature does not exceed 85°F.

On some enclosure tops, laser knockouts are provided if additional fans are necessary once all equipment has been installed.

IP Enabled monitoring solutions are increasingly employed to remotely monitor system temperatures to proactively address any concerns before they impact system uptime and reliability. These can also be set activate auxiliary fans as a backup/failsafe using simple logic commands, for example, to turn on if the temperature is greater than 100° F.

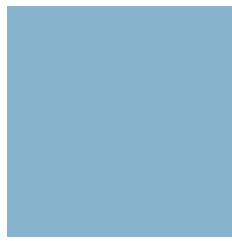

References

ASHRAE. (2009). 2009 ASHRAE Handbook - Fundamentals. ASHRAE.

ASHRAE Technical Committee 9.9, Mission Critical Facilities, Technology Spaces, and Electronic Equipment. (2009). Thermal Guidelines for Data Processing Environments, Second Edition. ASHRAE.

ASHRAE TC9.9 (2016) Data Center Power Equipment Thermal Guidelines and Best Practices Azar, K. (1997). Thermal Measurements in Electronics Cooling. Andover: CRC Press.

Coyne, J.C., 1982, An Approximate Thermal Model for Outdoor Electronics Cabinets (Bell System Technical Journal, Vol. 1, No. 2)

EIA. 2005. EIA-310, revision E, Dec. 1, 2005: Cabinets, Racks, Panels, and Associated Equipment.

ELLISON, G.N., 1995, Fan Cooled Enclosure Analysis Using First Order Method (Electronics Cooling Magazine, Vol. 1, No. 2)

ETS 300 019-2-3: May 1994/A1: June 1997, Environmental Conditions And Environmental Tests For Telecommunications Equipment

JDA, 1995, Meeting New Demands In Computer Room Air-Conditioning Kreith, F. (2000). CRC Handbook of Thermal Engineering. CRC Press.

Lall, P., Pecht, M., & Hakim, E. B. (1997). Influence of Temperature on Microelectronics and System Reliability. CRC Press.

MIASALE, M., 1993, Electronic cabinet cooling by natural convection: Influence of Vent Geometry

Schmidt, R., & Cruz, E. Raised Floor Computer Data Center: Effect on Rack Inlet Temperatures of Chilled Air Exiting Both the Hot and Cold Aisles. IBM Corporation.

SMACNA. (2004). HVAC Sound and Vibration Manual. Chantilly, VA: Sheet Metal and Air Conditioning Contractors' National Association.

SMACNA. (2006). HVAC Systems – Duct Design. Chantilly, VA: Sheet Metal and Air Conditioning Contractors' National Association.

SMACNA. (1987). HVAC Systems – Applications. Chantilly, VA: Sheet Metal and Air Conditioning Contractors' National Association.

SMACNA. (2002). HVAC Systems Testing, Adjusting and Balancing. Chantilly, VA: Sheet Metal and Air Conditioning Contractors' National Association.

Telcordia. 2001. Generic Requirements NEBS GR-3028-CORE, Thermal Management in Telecommunications Central Offices, Issue 1, December 2001, Telcordia Technologies, Inc., Piscataway, NJ.

THE UPTIME INSTITUTE, Changing Cooling Requirements Leave Many Data Centers at Risk, Version 1.0

VanGilder, J. A Non-Trial-and-Error CFD-Based Method for Balancing Airflow Through Floor Tiles in Raised Floor Data Centers. Flomerics.

CORPORATE HEADQUARTERS

300 Fairfield Road, Fairfield, NJ 07004, U.S.A.

Voice: 800-266-7225 • Fax: 800-392-3955

International Voice: +1 973 839-1011

International Fax: +1 973 831-4982

middleatlantic.com

CANADA

113 Iber Road, Ottawa, Ontario K2S 1E7

Voice: 888-766-9770 • Fax: 888-599-5009

middleatlantic.ca

FACTORY DISTRIBUTION

USA: New Jersey • California • Illinois

Canada: Ontario

The Netherlands: Eindhoven



Middle Atlantic Products

A brand of **legrand**