

# ELECTRICAL PRODUCT CATALOGUE



[www.ipexna.com](http://www.ipexna.com)

ISSUE DATE: OCTOBER 2019

- Rigid PVC Conduit & Fittings
- JBox™ Junction Boxes & Hinged Covers
- Nonmetallic Tubing & Fittings (ENT)
- PVC Raceway for Horizontal Directional Drilling (HDD)
- Nonmetallic Light Fixtures
- Power & Communication Duct
- Specialty Products

  
**IPEX**  
by aliaxis

**We build tough products for tough environments.®**



# Committed to EXCELLENCE

At IPEX Electrical Inc., we have been extruding PVC conduit and molding fittings since 1951. We formulate our own compounds, maintain strict quality control during production, and offer one of the most comprehensive lines of nonmetallic electrical products throughout North America.

More important, our commitment to customers extends beyond the sale. Quality control and thorough jobsite field reports have earned IPEX a reputation for product quality and service excellence.





# Contents

## EASY SPECIFICATIONS

### 01 RIGID PVC CONDUIT & FITTINGS

Scepter Rigid PVC Conduit & Fittings

### 29 NEXT GENERATION JUNCTION BOX

Scepter JBox

### 37 CONDUIT REPAIR

EPR Conduit Repair Kit

### 41 NONMETALLIC TUBING & FITTINGS

Cor-line ENT  
Kwikon Fittings

### 49 PVC RACEWAY FOR HDD

SceptaCon PVC for Horizontal Directional Drilling

### 53 NONMETALLIC LIGHT FIXTURES

Sceptalight Nonmetallic Light Fixtures

### 67 POWER & COMMUNICATIONS DUCT

Super Duct Power & Communications Duct  
Monobloc Spacers  
Underground Duct Spacers

### 77 SPECIALTY PRODUCTS

INEXO ICF Boxes  
Guy Guards

### 83 TELECOMMUNICATION SYSTEMS

FiberTel HDPE Innerduct



# ELECTRICAL EASY SPEC

PRODUCT	SIZE RANGE	STANDARDS	APPLICATIONS
<b>RIGID PVC CONDUIT &amp; FITTINGS</b>			
Scepter® Rigid PVC Conduit	1/2" - 8" (12mm - 200mm)	CSA C22.2 No. 211.2, No.211.0, UL651, NEMA TC2	Utilities, cable, communications, residential, airports, subways, bridges & tunnels, mines, marinas, water/sewage treatment plants, pulp & paper industries, street & highway lighting, food processing plants, agricultural, parking garages, car washes, fish plants, steel mills
Scepter® Rigid PVC Fittings	1/2" - 8" (12mm - 200mm)	CSA C22.2 No. 85, UL Listed, UL514B - UL514C	
EPR® Repair Kit	1-1/4" - 6" (30mm - 150mm)	N/A	DB II duct repair, rigid PVC repair, concrete encased, direct burial
<b>NONMETALLIC TUBING &amp; FITTINGS</b>			
Cor-Line® ENT	1/2" - 2-1/2" (12mm - 50mm)	CSA C22.2 No. 227.1, UL 1653, NEMA TC-13	Residential, commercial, institutional, hospitals & nursing homes, stadiums & arenas
Kwikon® Fittings	1/2" - 2-1/2" (12mm - 50mm)	CSA C22.2 No. 227.1, UL 514B	
<b>PVC RACEWAY FOR HORIZONTAL DIRECTIONAL DRILLING</b>			
Sceptacon™ PVC for HDD	2" - 6" (75mm - 150mm)	CSA C22.2 No. 211.0/211.2, UL 651, NEMATC2	Environmentally sensitive areas, historical landmarks, road & highway crossings, urban areas, street lights, traffic lights
<b>NONMETALLIC LIGHT FIXTURES</b>			
Sceptalight™	3/4" (19mm) Threaded hubs, Ceiling mount, Wall mount, Pendant mount	Wet Locations: CSA C22.2 No. 250, UL 1598 Hazardous Locations: UL 844 CLASS I, DIV 2 Groups A, B, C & D, CLASS II, DIV 2 Groups F & G	Chemical plant, food processing, highway tunnels, mine tunnels, walk-in freezers, industrial/commercial, marine, agricultural, waste water, greenhouses
<b>POWER &amp; COMMUNICATIONS DUCT</b>			
Super Duct® Pipe and Fittings	2" - 6" (50mm - 150mm)	CSA C22.2 No. 211.1	Utilities, telecom, hospitals/medical complexes, commercial buildings, communications, cable
Monobloc® Spacers	2" - 6" (50mm - 150mm)	N/A	Underground duct banks, medical campus, university campus
Interlocking Spacers	2" - 5" (50mm - 125mm)	N/A	Underground duct banks, medical campus, university campus
<b>SPECIALTY PRODUCTS</b>			
INEXO® ICF Boxes	1/2", 3/4", 1" (12mm, 19mm, 25mm)	CSA C22.2 No. 18.2, UL514C	Insulated concrete form (ICF) buildings, schools, churches, hotels
Guy Guards	6-1/2' - 7' (2m - 2.13m)	N/A	Support and stabilize poles & antennas
<b>TELECOMMUNICATION SYSTEMS</b>			
FiberTel® HDPE Innerduct	1/2" - 8" (12mm - 200mm)	N/A	Communication, data, cable television & general purpose ducting

# ELECTRICAL TYPE DESIGNATION

UL UNDERWRITERS LABORATORIES INC. (UL 50 AND UL 508)

TYPE DESIGNATION	STANDARD
1	Indoor use primarily to provide protection against contact with the enclosed equipment and against a limited amount of falling dirt.
2	Indoor use to provide a degree of protection against limited amounts of falling water and dirt.
3	Outdoor use to provide a degree of protection against windblown rain; undamaged by the formation of ice on the enclosure.
4	Either indoor or outdoor use to provide a degree of protection against falling rain, splashing water, and hose-directed water; undamaged by the formation of ice on the enclosure.
4X	Either indoor or outdoor use to provide a degree of protection against falling rain, splashing water, and hose-directed water; undamaged by the formation of ice on the enclosure; resists corrosion.
6P	Indoor or outdoor use primarily to provide a degree of protection against hose-directed water, the entry of water during prolonged submersion at a limited depth, and be undamaged by the formation of ice on the enclosure.
12	Indoor use to provide a degree of protection against dust, dirt, fiber flyings, dripping water, and external condensation of noncorrosive liquids.
13	Indoor use to provide a degree of protection and spraying of water, oil, and noncorrosive liquids.

This material is reproduced with permission from Underwriters Laboratories Inc. Standard for Safety for Cabinets and Boxes, UL 50, Copyright 1988 and Industrial Control Equipment, UL 508, Copyright 1994 by Underwriters Laboratories Inc.

Underwriters Laboratories Inc. (UL) shall not be responsible to anyone for the use of or reliance upon a UL Standard by anyone. UL shall not incur any obligation or liability for damages, including consequential damages, arising out of or in connection with the use, interpretation of, or reliance upon a UL Standard.

# Scepter® JBox™

The Next Generation Junction Box

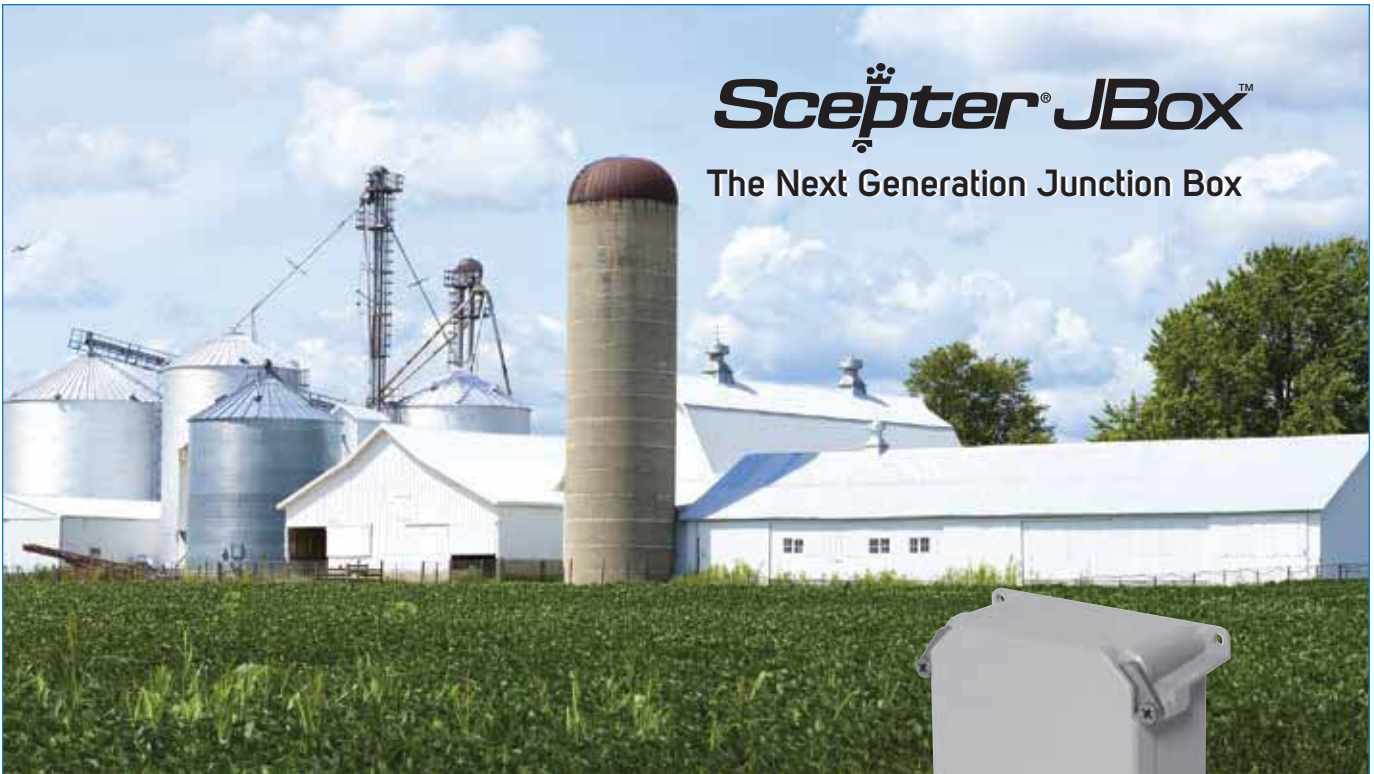

## Meet the FASTEST Junction Box to install anywhere!

We've completely redesigned the original junction box and added features to make this the quickest and easiest box for contractors to install – no matter the situation!

- ✓ Hand-close Fasteners
- ✓ Integrated Gasket
- ✓ Molded Mounting Feet
- ✓ Smooth Flat Cover
- ✓ Gridlines for drilling

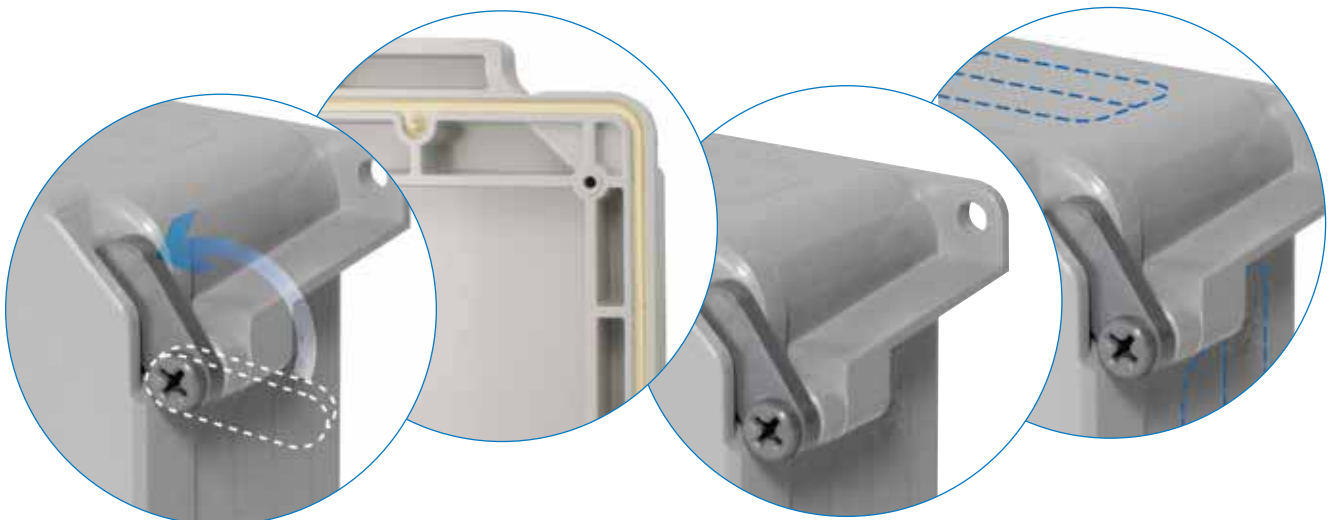

To get the full picture go to [ipexna.com](http://ipexna.com)

We introduced PVC pipe in 1951. Since then, the type of challenges industry faces have changed. What hasn't changed is our commitment to meeting your needs. For more than three generations, the Scepter® line of rigid conduit and fittings - manufactured today by IPEX Electrical Inc. - has stood for quality, innovation and service.

In addition to our Scepter® brand, we offer the industry's widest selection of electrical nonmetallic tubing and fittings, all backed by a single source. Each product is specifically engineered to meet or even exceed the demanding standards of the Canadian electrical construction industries.

# Rigid PVC Conduit & Fittings



Technical Information

2

Scepter Rigid PVC Conduit & Fittings

12

# SCEPTER RIGID PVC CONDUIT & FITTINGS

1/2" - 8" (12mm - 200mm)



Professional electricians ask for Scepter conduit by name for the quality and superior performance that ensures a long trouble free life. Scepter conduit is light weight and offers excellent chemical resistance, high tensile and impact strength, and the FT-4 rating permits use in noncombustible construction.

Suitable for exposed, concrete encased and direct burial applications, Scepter conduit requires no extra protection and is third party certified by CSA, UL and NRTL.

## SHORT FORM SPECIFICATIONS

All wiring shall be installed in Rigid PVC conduit and secured to PVC boxes and cabinets by means of proper fittings. All boxes, access fittings and covers shall be furnished with threaded brass inserts, brass screws and PVC gaskets.

Rigid PVC fittings and junction boxes shall be used for all outlets, pull boxes and junction points. All PVC junction boxes shall be NEMA 1, 2, 3, 4, 4X, 6P, 12 and 13 rated and UL Listed for wet locations.

Exposed conduit shall be securely held in place by suitable hangers or straps with the maximum spacing of points for supports not exceeding those specified in the CEC or NEC. Except when embedded in concrete, rigid conduit pipe shall not be clamped tightly. It shall be supported in such a manner as to permit adequate linear movement, allowing for expansion and contraction of conduit due to temperature change. Where a temperature change exceeding 25°F (14°C) is anticipated, rigid PVC expansion joints shall be installed in accordance with the manufacturer's recommendations.

Proper care shall be taken when field bending, to maintain the internal diameter and wall thickness of the conduit.

The contractor shall furnish and install Scepter Rigid PVC conduit pipe and fittings made by IPEX. Where the engineer's specifications indicate Scepter products or equivalent, the equivalent shall be CSA certified and accepted by the Canadian Electrical Code. Due to broad manufacturing tolerances, all pipe and fitting products shall be of the same manufacturer.

## APPLICATIONS

- Utilities
- Cable
- Communications
- Residential
- Airports
- Subways
- Bridges & tunnels
- Water treatment plants
- Sewage treatment plants
- Pulp & paper industries
- Street & highway lighting
- Food processing plants
- Agricultural, dairy, hogs, cattle, chicken, etc.
- Parking garages
- Car washes
- Fish plants
- Mines
- Marinas
- Steel mills

## STANDARDS



Scepter Rigid PVC Conduit conforms to: CSA C22.2 No. 211.2, CSA C22.2 No. 211.0  
NSF Certified to UL651  
Sunlight Resistant  
Rated for use with 90°C conductors  
NEMA TC2  
Corps. of Engineers Spec. CE 303:01  
Military Spec, Federal Spec. WC 1094A

Scepter Rigid PVC boxes and fittings conform to: CSA C22.2 No. 85

UL Listed UL514B - UL514C



## DID YOU KNOW?

Compared to metal, PVC products reduce labour on a typical installation by up to two-thirds. The reason? PVC is easy to work with. It can also be cut and joined without the usual pipe vices, cutters, threading equipment, and reamers associated with metal conduit.



## ADVANTAGES

- 1 Sunlight resistant**

Electrical nonmetallic Scepter Rigid PVC conduit meets the 2009 electrical code criteria for sunlight resistance, is approved for the purpose, and is appropriately marked.
- 2 Lightweight Conduit**

Scepter Rigid PVC Conduit is one-half the weight of aluminum and one-sixth the weight of steel. As a result, handling and installation are easier and faster, reducing labour costs.
- 3 Easy Joining**

Solvent cementing is all that is required, eliminating the need for power-threading machines, pipe vices and cutting equipment. A hacksaw or carpenter's saw is the only equipment required.
- 4 Strength**

Scepter Rigid PVC Conduit offers both high impact and high tensile strength. And, even in cold temperatures, exceeds all CSA and UL standards.
- 5 Easy Wire Pulls**

PVC's exceptionally smooth interior surface greatly reduces the amount of friction while pulling conductors/ wires through long runs, even with 90° bends. A large pull-rope and wire-pulling lubricant should be used when pulling all conductors and wires.
- 6 Noncorroding**

PVC is immune to damage from naturally corrosive soil conditions, as well as electro-chemical and galvanic corrosion. This ensures lower maintenance costs and superior performance.
- 7 Nonconducting**

Scepter Rigid PVC Conduit pipe and fittings are nonsparking and nonconducting, thereby eliminating the most dangerous 'second point of contact' and 'phase to ground' faults. The use of a separate grounding conductor in a Scepter PVC conduit system gives a complete and positive ground for the whole system.
- 8 Chemical resistance**

One of the greatest benefits of PVC is its excellent chemical resistance. It resists attack by acids, alkalis, salt solutions, and many other types of chemicals. For more information on PVC and chemical resistance, refer to the IPEX Chemical Resistance Guide.
- 9 Long Life**

Scepter Rigid PVC Conduit pipe and fittings retain their original properties after years of exposure to heat and weather. In addition, resistance to fungi, bacterial action, rodents, termites and corrosive agents ensures a long, trouble-free life for PVC conduit installed indoors or outdoors.
- 10 Fire Resistant**

As a building material PVC offers outstanding fire performance characteristics. PVC will not burn unless an external flame source is applied, and will not sustain ignition once the flame source is removed. PVC has a flash ignition temperature of 850°F.
- 11 Concrete Tight**

Scepter Rigid PVC Conduit pipe and fittings are designed and engineered to be concrete tight in all weather conditions.

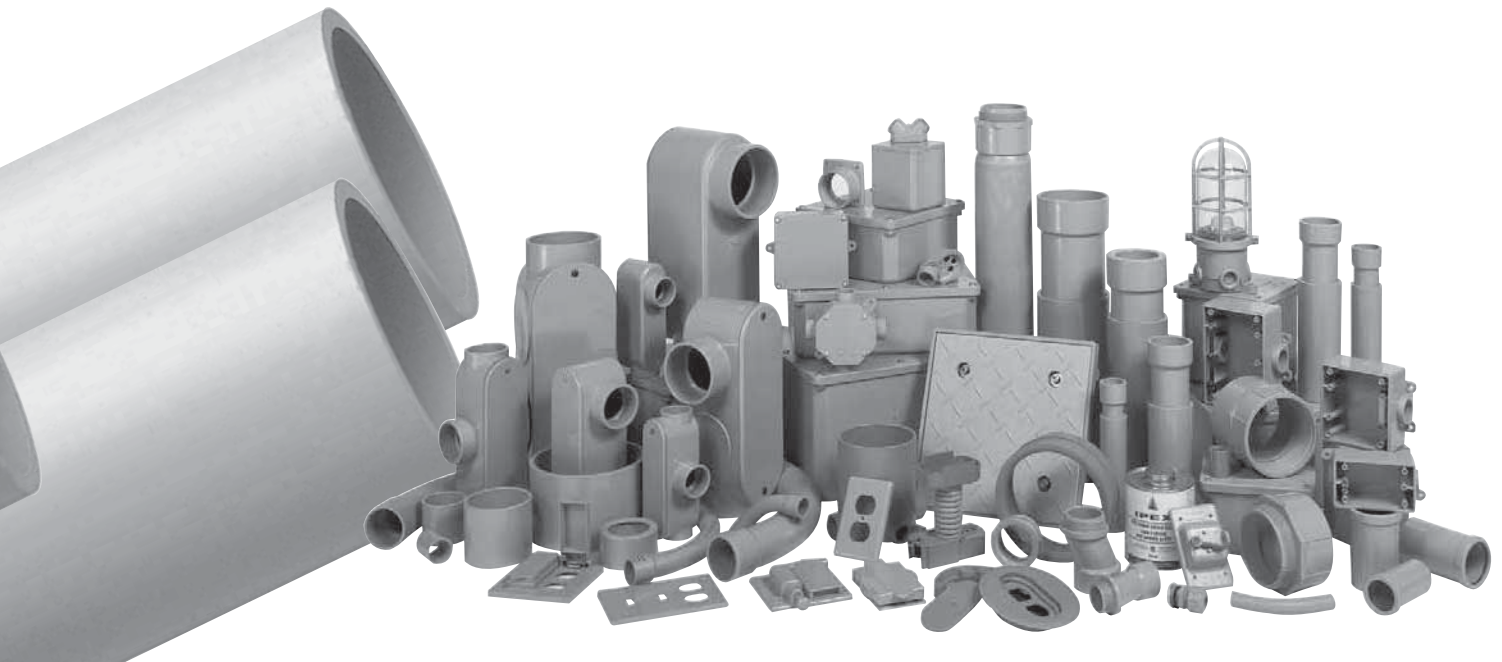

## TECHNICAL INFORMATION

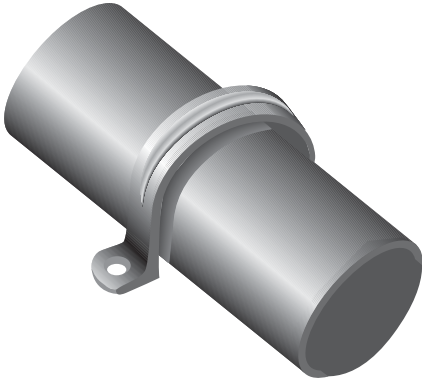

### SUPPORT

Due to PVC's light weight, support spacing is different than that used with metal conduits. Supporting straps should NOT be firmly tightened, so that linear movement of the pipe is possible. The maximum allowable support spacing, per the Canadian Electrical Code (CEC) is as follows:

### SUPPORT SPACING

Nominal Conduit Diameter		Canadian Electrical Code Max. Support Spacing	
inches	mm	feet	metres
1/2	12	2-1/2	.75
3/4	20	2-1/2	.75
1	25	2-1/2	.75
1-1/4	32	4	1.20
1-1/2	40	4	1.20
2	50	5	1.50
2-1/2	65	6	1.80
3	75	6	1.80
3-1/2	90	7	2.10
4	100	7	2.10
5	125	7	2.10
6	150	8	2.50



### MAX OPERATING TEMPERATURE

The Canadian Electrical Code (CEC) allows the use of Scepter Rigid PVC Conduit up to a maximum ambient temperature of 167°F (75°C).

### CUTTING

Scepter Rigid PVC Conduit can be easily cut on the jobsite by using a hacksaw, carpenter's saw or PVC conduit cutters. For larger sizes of conduit, the use of a mitre box is also recommended to ensure a square cut.

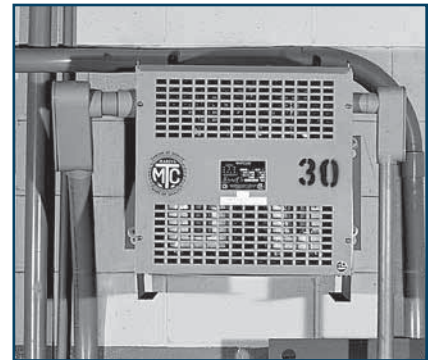

## TECHNICAL INFORMATION

### SOLVENT CEMENTING

After cutting Scepter Rigid PVC Conduit, remove all sharp edges or burrs from the inside of the conduit with a knife. Thoroughly clean the end of the pipe and inside the fitting with a rag or pipe cleaner. Check the pipe and fitting for a dry fit before cementing. Apply a generous amount of IPEX solvent cement to both surfaces; slide together and give a quarter turn to ensure the solvent is spread evenly on the material. Hold together for a few seconds until the joint is made.

Usually the solvent-cemented joint will be strong enough to install immediately. However, in climates with low temperatures or areas with high humidity, extra time may be required before moving the pipe for permanent installation. Solvent-cemented joints appear to “set up” instantly, but will take up to 24 hours to cure properly. After this time, the solvent-cemented joint has completely cured and is waterproof. For extreme cold weather installations, the use of IPEX PVC Primer is recommended. Normal installation temperatures are between 40°F (4°C) and 110°F (43°C), however, high strength joints have been made at temperatures as low as -15°F (-26°C) with quality cements. In these extreme conditions the cement must be kept warm to prevent excessive thickening and gelation in cold weather.

IPEX cements and primers are available in quarter-pint (125ml), half-pint (250ml), pint (500ml), quart (1-litre) and gallon (4-litre) containers. The shelf life of conduit cement and primer is 2 years from the date of manufacture. The date code stamped on the bottom of the can is the date of manufacture, not the expiry date. Always verify that the cement is within this 2 year time frame before using.



### BENDING

PVC is a thermoplastic material that, when heated, becomes soft and pliable. As a result, its shape can be altered.

A flameless heat source is recommended to heat the pipe. AN OPEN FLAME SHOULD NOT BE USED. An electric unit or an infra-red propane unit is recommended for heating the pipe.

The necessary temperature for bending Scepter Rigid PVC pipe is 260°F (127°C). The pipe must be heated evenly over an area approximately ten times the diameter of the pipe before any attempt at bending is made. Bending the pipe when it has not been thoroughly heated will cause the pipe to “kink.” With proper care and a little practice, the bend will form easily.

Cooling the pipe with cold air or water will cause “spring back.” Allow a few extra degrees of overbending to compensate for this phenomenon. The maximum bending radius shall be six times the internal diameter according to the Canadian Electrical Code and the National Electrical Code.



# TECHNICAL INFORMATION EXPANSION FITTINGS

## USING EXPANSION JOINTS

It is equally important to know when to install an expansion joint as it is to know how to correctly install the expansion joint. Expansion joints are required when the temperature change is greater than 25°F (14°C). Scepter Rigid PVC Conduit has a coefficient of linear expansion of  $3.6 \times 10^{-4}$  in./ft./°F (.054mm/m/°C). Generally, a 100 ft. (30.48m) run of PVC conduit will undergo a change in length of 3.6 inches (91.44mm) for every 100°F (56°C) temperature change.

For conduit installed indoors, the range of expansion and contraction can be calculated using the maximum air temperature plus the heat contributed by the conductors inside the conduit and the minimum air temperature expected. Expansion joints are not required indoors unless there are widely varying temperatures such as the attic of a building.

Conduit installed outdoors, exposed to direct sunlight, will be considerably hotter than the air temperature. As a guideline in this case, add 27°F (15°C) to the temperature change. Expansion joints should be installed to allow for all anticipated temperature changes.

## EXPANSION FORMULA

By using the following formulas and the charts below, the total expected expansion in a run can be easily determined:

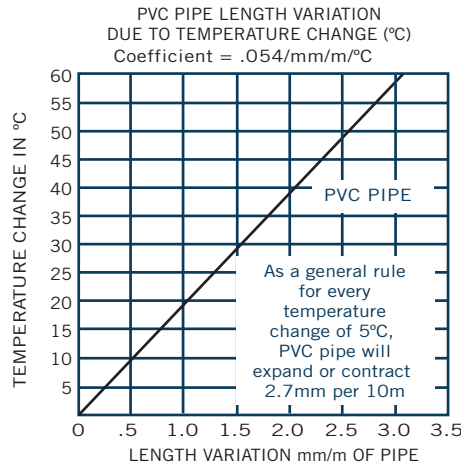
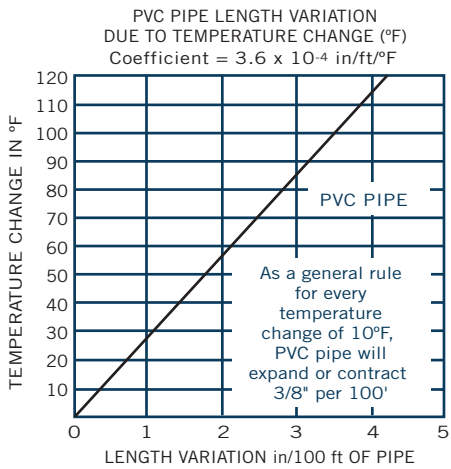

°F Total Expansion (in.) = length of run (ft.)  
x temperature change (°F) x 0.00036

or

°C Total Expansion (mm) = length of run (m)  
x temperature change (°C) x 0.054

# TECHNICAL INFORMATION EXPANSION FITTINGS

## NUMBER OF EXPANSION JOINTS REQUIRED

Use the following equation to determine the number of expansion joints needed for a Scepter Rigid PVC Conduit installation:

$$\text{Number of joints} = \frac{\text{total expansion (mm or in)}}{E}$$

E = Expansion joint travel length 101.6mm (4") or 203.2mm (8") depending on diameter.

Always round up to the next whole number.

## SETTING THE PISTON OPENING

The expansion joint must be installed to allow for expansion and contraction of the conduit run. On a cold day, if an expansion joint is installed completely closed with the piston bottomed, there is no room for expansion when the conduit is warmed. If it is installed open to the maximum on a hot day, the expansion joint will pull apart when cooled.

The correct piston opening for any installation condition can be easily determined using the formula below.

$$\text{Piston setting} = \text{compressed length} + \left( \frac{\text{max. temperature} - \text{installation temperature}}{\text{max. temperature} - \text{min. temperature}} \right) \times E$$

Formula can be used for both metric and imperial measurements.

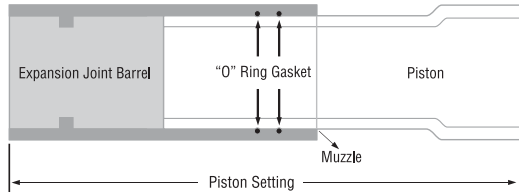

Size		Compressed Length		Travel	
(mm)	(in)	(mm)	(in)	(mm)	(in)
13	1/2	203.2	8.00	101.6	4
20	3/4	203.2	8.00	101.6	4
25	1	215.9	8.50	101.6	4
32	1-1/4	228.6	9.00	101.6	4
38	1-1/2	228.6	9.00	101.6	4
51	2	235.0	9.25	101.6	4
64	2-1/2	235.0	9.25	101.6	4
76	3	362.0	14.25	203.2	8
89	3-1/2	362.0	14.25	203.2	8
102	4	362.0	14.25	203.2	8
127	5	362.0	14.25	203.2	8
152	6	362.0	14.25	203.2	8

## COMMON MISTAKES

Three common mistakes are:

1. Forgetting to use expansion joints.
2. Not using enough expansion joints.
3. Overtightening of support straps.

It is more cost effective to use more expansion joints than needed, rather than too few. It is difficult to correct the problem after conductors are installed and in service. Failure to accommodate expansion/contraction may result in pipe fracture.

# TECHNICAL INFORMATION EXPANSION FITTINGS

## INSTALLATION OF EXPANSION JOINTS

### USING EXPANSION JOINTS

Proper functioning of an expansion joint depends on three procedures:

1. The correct placement of the expansion joint.
2. The proper installation of Scepter Rigid PVC Conduit and the expansion joint.
3. The proper placement and fastening of support straps.

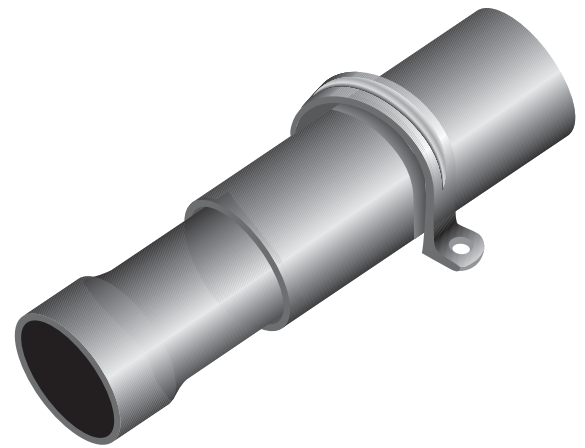

#### One Expansion Joint - Figure 1

If only one expansion joint is needed between two boxes, the barrel of the joint should be rigidly fastened close to the first box. Scepter Rigid PVC Conduit should then be loosely supported with straps, allowing the conduit to move freely as it expands and contracts.

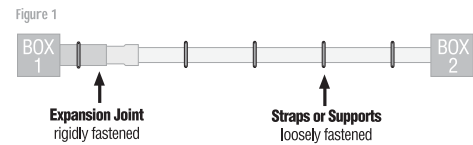

#### Two Expansion Joints - Figure 2

If two expansion joints are needed, the joints should be firmly fastened back to back at the centre of the run. Scepter Rigid PVC Conduit should be loosely supported with straps, allowing the conduit to move freely as it expands and contracts.

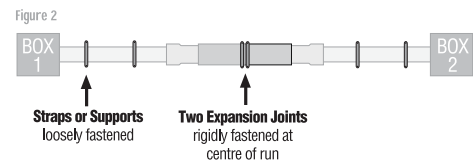

#### Two Expansion Joints (Alternative) - Figure 3

Alternatively, the centre of the run and the two expansion joints (located at the boxes) should be rigidly fastened. All other support straps should be loosely fastened.

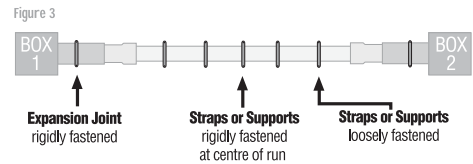

#### Three or More Expansion Joints - Figure 4

If more than two joints are needed in a very long run, they should be put in a series, one after the other. Each barrel must be rigidly fastened while conduit is loosely supported with straps allowing the conduit to move freely as it expands and contracts. When installed in a series, each section acts independently of the other. Spacing of conduit supports must be in accordance with Section 12-1114 of the Canadian Electrical Code or NEC Article 347-8. (See Table on Support Spacing)

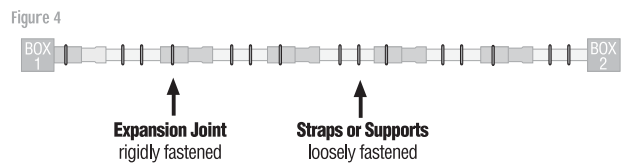

## INSTALLATION RECOMMENDATIONS

- Expansion joints should be mounted so the piston can travel in a straight line in the barrel. If the alignment is not straight, the piston will bind, preventing the joint from functioning correctly.
- The expansion joint barrel should be clamped tight, but the conduit mounted loose enough in its hangers to allow for movement as it expands and contracts.
- Scepter nonmetallic straps are correctly sized and designed for proper support, and must be used to secure the conduit.
- When expansion joints are used in a vertical position, the piston should be mounted in a downward position so dirt cannot deposit between the barrel and piston at the muzzle of the expansion joints.

## TECHNICAL INFORMATION

Nominal Size		Rigid PVC		Aluminum		Rigid Steel	
inches	mm	lbs/100ft	kg/100m	lbs/100ft	kg/100m	lbs/100ft	kg/100m

### Weight Comparison of Rigid PVC Conduit

1/2	12	15	23	28	41	79	118
3/4	20	21	31	27	54	105	157
1	25	31	46	53	79	153	228
1-1/4	32	42	63	70	104	201	300
1-1/2	40	53	78	86	129	249	371
2	50	71	106	116	173	334	498
2-1/2	65	112	167	183	272	527	786
3	75	166	248	239	356	690	1029
3-1/2	90	200	298	288	429	831	1239
4	100	236	352	340	507	982	1464
5	125	321	479	465	694	1334	1989
6	150	417	621	613	914	1771	2641

## PRODUCT SELECTION CHART & DIMENSIONS

Nominal Size		Product Code	O.D.		I.D.		Min. Wall		Weight		Standard ft./crate
inches	mm		inches	mm	inches	mm	inches	mm	lbs./100	kg/100m	

### Rigid conduit

1/2	12	(10')	032105	0.840	21.3	0.622	15.8	0.109	2.8	15	22.6	6,000
		(20')	032106									12,000
3/4	20	(10')	032107	1.050	26.7	0.824	20.9	0.113	2.9	21	31.2	4,400
		(20')	032108									8,800
1	25	(10')	032110	1.315	33.4	1.049	26.6	0.133	3.4	31	46.2	3,600
		(20')	032111									7,200
1-1/4	32	(10')	032112	1.660	42.2	1.380	35.1	0.140	3.6	42	63.0	3,300
		(20')	032114									6,600
1-1/2	40	(10')	032115	1.900	48.3	1.610	40.9	0.145	3.7	53	78.4	2,250
		(20')	032116									4,500
2	50	(10')	032120	2.375	60.3	2.067	52.5	0.154	3.9	71	105.5	1,400
		(20')	032121									2,800
2-1/2	65	(10')	032125	2.875	73.0	2.469	62.7	0.203	5.2	112	167.2	780
		(20')	032126									1,560
3	75	(10')	032130	3.500	88.9	3.068	77.9	0.216	5.5	166	247.8	780
		(20')	032131									1,560
3-1/2	90	(10')	032135	4.000	101.6	3.548	90.1	0.226	5.7	200	297.7	630
		(20')	032136									1,260
4	100	(10')	032140	4.500	114.3	4.026	102.3	0.237	6.0	236	352.4	600
		(20')	032141									1,200
5	125	(10')	032150	5.563	141.3	5.047	128.2	0.258	6.6	321	478.5	230
		(20')	032151									460
6	150	(10')	032160	6.625	168.3	6.065	154.1	0.280	7.1	417	621.0	260
		(20')	032161									520
8	200	(10')	032180	8.620	219.0	7.980	202.6	0.322	8.18	559	833.1	140
		(20')	032181									280

## PHYSICAL PROPERTIES OF PVC TYPE II

Properties	Unit	Value	ASTM Test Method
<b>Electrical</b>			
Dielectric Strength	volts/mil	1215	D149
Dielectric Constant	60 cps at 30°C	3.55	D150
	1000 cps at 30°C	3.22	D150
Power Factor	60 cps at 30°C	4.04	D150
	1000 cps at 30°C	4.71	D150
<b>Physical</b>			
Specific Gravity		13.5	D792
Hardness	Durometer D	78	D676
Izod Impact Strength @ 73°F (23°C)	ft.lb/in. notch	15.0	D256
Tensile Strength @ 73°F (23°C)	psi	6000	D638
Compressive Strength	psi	8600	D695
Flexural Strength	psi	11500	D790
<b>Thermal</b>			
Coefficient of Thermal Conductivity	BTU/sec/in <sup>2</sup> /°F/in.	0.11	C177
Coefficient of Linear Expansion	per °F x 10 <sup>-5</sup>	5.5	D696
Heat Distortion Temperature at 264 psi	°F	158	D648
<b>Others</b>			
Flammability		self-extinguishing	D635
Water Absorption in 30 days	%	0.6	
Colour		charcoal grey	
Light Transmission		opaque	D791

All technical data is believed to be accurate and is presented solely for information and guidance.



# IPEX TECHNICAL MANUALS available at [www.ipexna.com](http://www.ipexna.com)

Obtaining the most up-to-date technical information has never been easier with our on-line **TECHNICAL LIBRARY**



## WHAT YOU CAN DO



Quickly view documents



Download as PDFs



Email single and multiple files



Environmentally Friendly!



Visit [www.ipexna.com](http://www.ipexna.com)  
& check it out!

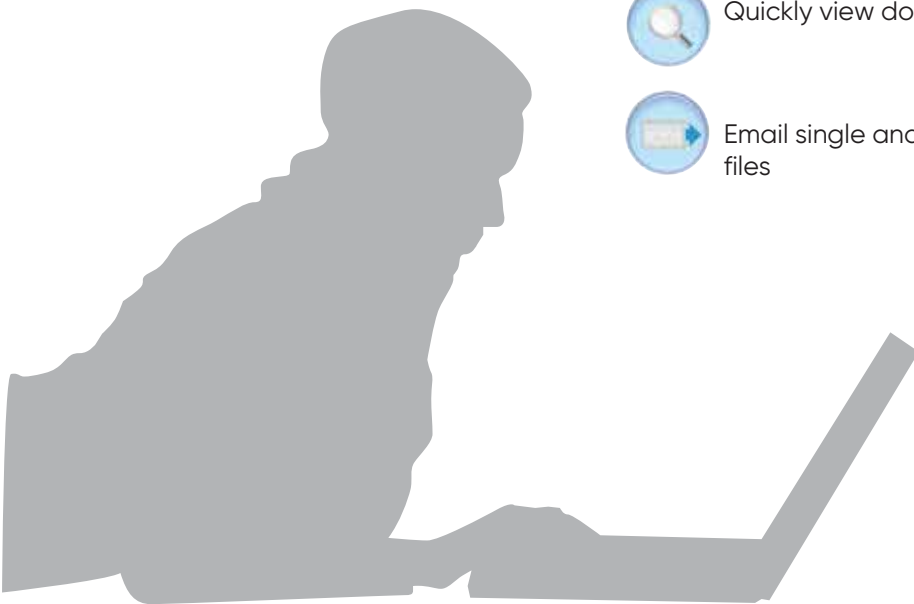

# CONDUIT ELBOWS

Size inches	Part Number	Product Code	D inches	T inches	R inches
-------------	-------------	--------------	----------	----------	----------

## 90° Elbows c/w Solvent Bell End (Bell End x Plain End)



*plain end x plain end only	1/2	EE1090	069081	0.840	1.500	4.00
	3/4	EE1590	069082	1.050	1.500	4.50
	1	EE2090	069083	1.315	1.875	5.75
	1-1/4	EE2590	069084	1.660	2.000	7.25
	1-1/2	EE3090	069085	1.900	2.000	8.25
	2	EE3590	069086	2.375	2.000	9.50
	2-1/2	EE4090	069087	2.875	3.000	10.50
	3	EE4590	069088	3.500	3.125	13.00
	3-1/2*	EE5090	069089	4.000	3.250	15.00
	4	EE5590	069090	4.500	3.375	16.00
	5	EE6090	069091	5.563	3.625	24.00
	6	EE6590	069092	6.625	3.750	30.00
	8*	EE7090	069099	8.622	8.300	48.00

## 45° Elbows c/w Solvent Bell End (Bell End x Plain End)

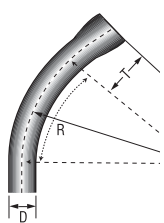

*plain end x plain end only	1/2	EE1045	069201	0.840	1.500	4.00
	3/4	EE1545	069202	1.050	1.500	4.50
	1	EE2045	069203	1.315	1.875	5.75
	1-1/4	EE2545	069204	1.660	2.000	7.25
	1-1/2	EE3045	069205	1.900	2.000	8.25
	2	EE3545	069206	2.375	2.000	9.50
	2-1/2	EE4045	069207	2.875	3.000	10.50
	3	EE4545	069208	3.500	3.125	13.00
	3-1/2*	EE5045	069209	4.000	3.250	15.00
	4	EE5545	069210	4.500	3.375	16.00
	5	EE6045	069211	5.563	3.625	24.00
	6	EE6545	069212	6.625	3.750	30.00
	8*	EE7045	069213	8.622	8.300	48.00

## 30° Elbows Plain End x Plain End

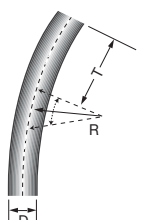

*plain end x plain end only	1/2	EE1030	069241	0.840	1.500	4.00
	3/4	EE1530	069242	1.050	1.500	4.50
	1	EE2030	069243	1.315	1.875	5.75
	1-1/4	EE2530	069244	1.660	2.000	7.25
	1-1/2	EE3030	069245	1.900	2.000	8.25
	2	EE3530	069246	2.375	2.000	9.50
	2-1/2	EE4030	069247	2.750	3.000	10.50
	3	EE4530	069248	3.500	3.125	13.00
	3-1/2	EE5030	069249	4.000	3.250	15.00
	4	EE5530	069250	4.500	3.375	16.00
	5	EE6030	069251	5.563	3.625	24.00
	6	EE6530	069252	6.625	3.750	30.00
	8	EE7030	069254	8.622	8.300	48.00

## Utility 90° Elbows c/w Solvent Bell End (Bell End x Plain End)

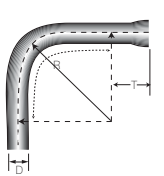

*plain end x plain end only	2	NSL 2-24	069257	2.375	41.200	24.00
	2	NSL 2-36	069260	2.375	31.700	36.00
	3	NSL 3-24	069265	3.500	41.200	24.00
	3	NSL 3-36	069261	3.500	31.700	36.00
	4	NSL 4-36	069267	4.500	31.700	36.00
	4	NSL 4-48	069266	4.500	31.700	48.00
	5	NSL 5-36	069263	5.563	31.700	36.00
	6	NSL 6-36	069264	6.625	31.700	36.00

CSA Utility 90° Elbows are made from 10 ft. pipe.

## CONDUIT FITTINGS

Size inches	Part Number	Product Code
-------------	-------------	--------------

### Pipe Straps PVC 2 Hole



1/2	PS10	077811
3/4	PS15	077812
1	PS20	077813
1-1/4	PS25	077814
1-1/2	PS30	077815
2	PS35	077816

### Pipe straps Polyethylene (PE) 2 Hole



2-1/2	PS40	077262
3	PS45	077263
4	PS55	077264

### Nonmetallic Conduit Clamps & Wall Spacers



1/2	CCS10	077794
3/4	CCS15	077796
1	CCS20	077797
1-1/4	CCS25	077798
1-1/2	CCS30	077799
2	CCS35	077800
Base	CCS-B	077343

Note: CCS-B are sold individually, two pieces are required to create one base unit.

Size inches	Part Number	Product Code
-------------	-------------	--------------

### Pipe straps Coated Steel 1 Hole



1/2	CS10-1	077831
3/4	CS15-1	077832
1	CS20-1	077833
1-1/4	CS25-1	077834
1-1/2	CS30-1	077835
2	CS35-1	077836
2-1/2	CS40-1	077837
3	CS45-1	077838
3-1/2	CS50-1	077839
4	CS55-1	077840

### Pipe straps Coated Steel 2 Hole



2	CS35	077818
2-1/2	CS40	077819
3	CS45	077820
3-1/2	CS50	077821
4	CS55	077822
5	CS60	077824
6	CS65	077823

Visit our website: [www.ipexna.com](http://www.ipexna.com)

## PRODUCT INFO

TECHNICAL DOCUMENTS  
& MUCH MORE ...

## DOWNLOAD

OUR SCEPTER  
ELECTRICAL CATALOGUE  
OR OUR ELECTRICAL  
POCKET PRO

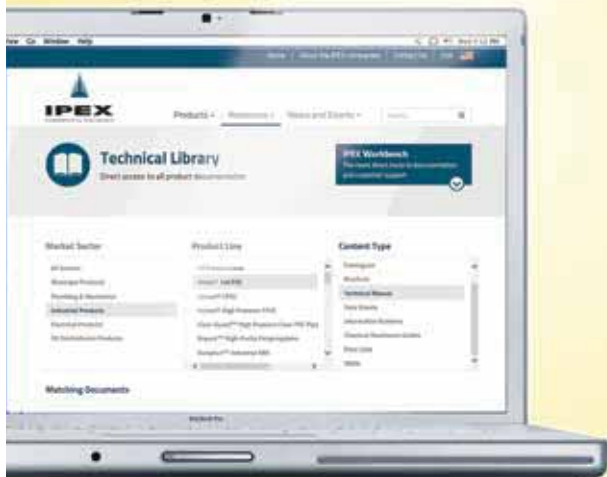

## CONDUIT FITTINGS

Size inches	Part Number	Product Code	A inches	B inches	C inches
-------------	-------------	--------------	----------	----------	----------

### Couplings

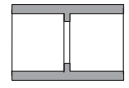

1/2	EC10	077001	1.080	0.840	1.437
3/4	EC15	077002	1.300	1.050	1.703
1	EC20	077003	1.590	1.315	2.031
1-1/4	EC25	077004	2.000	1.660	2.156
1-1/2	EC30	077005	2.230	1.900	2.281
2	EC35	077006	2.720	2.375	2.406
2-1/2	EC40	077007	3.320	2.875	3.187
3	EC45	077008	4.000	3.500	3.437
3-1/2	EC50	077009	4.500	4.000	3.625
4	EC55	077010	5.000	4.500	3.750
5	EC60	077011	6.120	5.563	4.187
6	EC65	077012	7.370	6.625	4.562

Size inches	Part Number	Product Code	L inches
-------------	-------------	--------------	----------

### 5° couplings

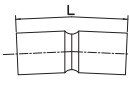

2	5EC35	077100	4.0
2-1/2	5EC40	077101	5.5
3	5EC45	077103	6.0
3-1/2	5EC50	077102	7.0
4	5EC55	077104	7.0
5	5EC60	077105	7.5
6	5EC65	077106	11.0

Size inches	Part Number	Product Code	A inches	B inches	C inches	D inches
-------------	-------------	--------------	----------	----------	----------	----------

### Terminal Adapters 1/2" - 1-1/4" Tapered Thread; 1-1/2" - 6" Non-Tapered Thread

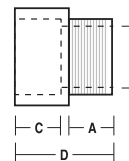

1/2	TA10	077021	0.700	0.591	0.750	1.550
3/4	TA15	077022	0.675	0.790	1.000	1.750
1	TA20	077023	0.625	1.000	1.115	1.860
1-1/4	TA25	077024	0.640	1.311	1.300	2.125
1-1/2	TA30	077025	0.725	1.530	1.425	2.250
2	TA35	077026	0.800	1.970	1.150	2.100
2-1/2	TA40	077027	0.800	2.346	1.900	2.930
3	TA45	077028	0.815	2.915	2.000	3.055
3-1/2	TA50	077029	1.000	3.385	1.715	3.055
4	TA55	077030	0.815	3.850	1.990	3.215
5	TA60	077031	1.105	4.810	2.000	5.985
6	TA65	077032	1.105	5.825	2.130	6.500

# CONDUIT FITTINGS

Size inches	Part Number	Product Code	A inches	B inches	C inches	D inches
-------------	-------------	--------------	----------	----------	----------	----------

## Female Adapters NPT Tapered Thread

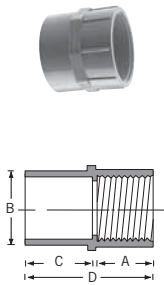

1/2	FA10	077041	0.800	0.620	0.825	1.725
3/4	FA15	077042	0.800	0.820	1.000	1.900
1	FA20	077043	1.000	1.065	1.200	2.300
1-1/4	FA25	077044	1.015	1.395	1.300	2.425
1-1/2	FA30	077045	1.050	1.575	1.290	2.440
2	FA35	077046	1.075	2.050	1.375	2.550
2-1/2	FA40	077047	1.675	2.470	1.985	3.760
3	FA45	077048	1.630	3.090	2.150	4.100
3-1/2	FA50	077049	1.800	3.540	2.000	3.985
4	FA55	077050	1.755	4.025	2.185	4.210
5	FA60	077051	2.065	5.035	3.000	5.240
6	FA65	077052	2.065	6.045	3.000	5.235

Size inches	Part Number	Product Code
-------------	-------------	--------------

## Neoprene O-Ring\*



1/2	E943DX	077033
3/4	E943EX	077034
1	E943FX	077035
1-1/4	E943GX	077036
1-1/2	E943HX	077037
2	E943JX	077038
3	E943LX	077040
4	E943NX	077058

\* For use with TA to obtain a water-tight seal.

## Reducer Bushings



3/4 x 1/2	1805	077300
1 x 1/2	1805-1	077301
1 x 3/4	1806	077302
1-1/4 x 3/4	1807-1	077303
1-1/4 x 1	1807	077304
1-1/2 x 1	1808-1	077305
1-1/2 x 1-1/4	1808	077306
2 x 1	1809-1	077313
2 x 1-1/4	1809	077307
2 x 1-1/2	1810	077308
2-1/2 x 2	1811	077309
3 x 2	1812-1	077310
3 x 2-1/2	1812	077311
4 x 2	1813-1	077319
4 x 3	1813	077312
4 x 3-1/2	1814	077317

## Threaded Reducer Bushings



3/4 x 1/2	1825	077314
1 x 1/2	1826	077315
1 x 3/4	1827	077316

Size inches	Part Number	Product Code
-------------	-------------	--------------

## End Caps



1/2	CAP10	077421
3/4	CAP15	077422
1	CAP20	077423
1-1/4	CAP25	077424
1-1/2	CAP30	077425
2	CAP35	077426
2-1/2	CAP40	077427
3	CAP45	077428
3-1/2	CAP50	077429
4	CAP55	077430
5	CAP60	077431
6	CAP65	077432
8	CAP80	077657

## End Bells



1/2	EB10	077406
3/4	EB15	077085
1	EB20	077323
1-1/4	EB25	077324
1-1/2	EB30	077325
2	EB35	077326
2-1/2	EB40	077327
3	EB45	077328
3-1/2	EB50	077329
4	EB55	077330
5	EB60	077331
6	EB65	077332
8	EB80	277094

**NEW**  
Molded

## EXPANSION FITTINGS

For use with Scepter rigid PVC conduit, Scepter Expansion Fittings accommodate for conduit thermal expansion and contraction. Available in an extensive range of sizes, expansion fittings are easily installed for each specific installation. For best performance, it is recommended that the EK is positioned immediately below the meter socket.

Size inches	Part Number	Product Code	A (inches) max.	B (inches) min.	Travel inches
-------------	-------------	--------------	-----------------	-----------------	---------------

### "O" Ring Expansion Joints

Size inches	Part Number	Product Code	A (inches) max.	B (inches) min.	Travel inches
1/2	EJ10	077381	12.00	8.00	4
3/4	EJ15	077382	12.00	8.00	4
1	EJ20	077383	12.50	8.50	4
1-1/4	EJ25	077384	13.00	9.00	4
1-1/2	EJ30	077385	13.00	9.00	4
2	EJ35	077386	13.25	9.25	4
2-1/2	EJ40	077387	13.25	9.25	4
3	EJ45	077388	22.25	14.25	8
3-1/2	EJ50	077389	22.25	14.25	8
4	EJ55	077390	22.25	14.25	8
5	EJ60	077391	22.25	14.25	8
6	EJ65	077392	22.25	14.25	8

Size inches	Part Number	Product Code
-------------	-------------	--------------

### Expansion & Deflection Fitting Assemblies

2	SE-J-35	077889
3	SE-J-45	077890
4	SE-J-55	077891

complete assembly

Size inches	Part Number	Product Code	A Dia. inches	2 Length	3 Length	Overall Length
-------------	-------------	--------------	---------------	----------	----------	----------------

### One Piece Expansion Joints (OPEJ)

1/2	OPEJ10	077018	1.102	0.60	2.465	3.25
3/4	OPEJ15	077019	1.314	0.729	2.646	3.50
1	OPEJ20	077053	1.610	0.885	2.725	3.75
1-1/4	OPEJ25	077054	1.987	0.950	2.895	4.00
1-1/2	OPEJ30	077061	2.208	1.075	3.030	4.25
2	OPEJ35	077063	2.701	1.140	3.206	4.50

## CONDUIT FITTINGS

**NEW**

The NEW Strain Relief Connectors come with everything needed to make a cable connection. The package includes a connector body, cap, and grommets that cover a wide range of cable types and sizes to provide added flexibility on the jobsite.

These new specially designed grommets have collapsing teeth and an inverting membrane which secures cables and provides exceptional strain relief at termination points. The grommets are made from a specially formulated TPE material that provides exceptional grip and durability.



Size inches	Configuration	Part Number	Product Code	
			NEW	OLD

### Nonmetallic Threaded Strain Relief Connectors c/w "O"Ring, Locknut & 6 Grommets

1/2	Threaded	TSRC10A	277081	077754
3/4	Threaded	TSRC15A	277079	077756
3/4	Solvent Cement	SRC15A	277080	077985

### Strain Relief Connectors Grommet Dimensions



Round Small Grommet  
0.335" to 0.395"



Round Medium Grommet  
0.395" to 0.495"



Round Large Grommet  
0.495" to 0.575"



Oval Large Grommet  
0.451" to 0.225" to 0.585" x 0.282"

## CEMENTS AND PRIMERS

Size	Part Number	Product Code
------	-------------	--------------

### Conduit Cement c/w Applicator Cap



125ml	S100PT25	074717
250ml	S100PT5	074713
500ml	S100PT	074714
1L	S100QT	074715
4L	S100GAL	074716

Size	Part Number	Product Code
------	-------------	--------------

### Primer



250ml	C100PT5	074306
500ml	C100PT	074307
1L	C100QT	074308

### AVERAGE # OF JOINTS PER PINT OR QUART OF CEMENT

Nominal Pipe Size		# of Joints per Pint	# of Joints per Quart	Nominal Pipe Size		# of Joints per Pint	# of Joints per Quart
inches	mm			inches	mm		
1/2	12	350	700	2-1/2	12	40	80
3/4	19	200	400	3	19	35	70
1	25	150	300	3-1/2	25	30	60
1-1/4	32	110	220	4	32	24	48
1-1/2	38	80	160	5	38	10	20
2	50	45	90	6	50	8	16

# ACCESS FITTINGS

No other manufacturer offers such an extensive range of access fitting sizes (1/2" to 4") or hub configurations (LB, T, LL, LR, TB, C, E). CSA certified and UL listed, Scepter access fittings come fully factory assembled so parts cannot be misplaced during shipping and handling.

Manufactured with threaded brass screws and inserts, and flexible PVC gaskets, Scepter access covers can be removed as often as needed without wear or cracking. Stainless steel screws are available on request.

Size inches	A inches	B inches	C inches	D inches	E inches	F inches
-------------	----------	----------	----------	----------	----------	----------

Access Fitting Dimensions

1/2	5.6	0.6	1.3	1.1	0.8	4.3
3/4	5.6	0.8	1.5	1.3	1.1	5.4
1	6.5	0.9	1.7	1.6	1.3	6.3
1-1/4	7.9	1.1	2.3	2.0	1.7	7.6
1-1/2	8.5	1.1	2.7	2.3	1.9	8.3
2	10.9	1.2	3.2	2.8	2.4	10.5
2-1/2	14.6	1.8	4.5	4.0	2.9	13.6
3	14.6	1.9	4.5	4.0	3.5	13.6
3-1/2	17.0	2.1	5.5	5.0	4.0	16.0
4	17.0	2.1	5.5	5.0	4.5	16.0

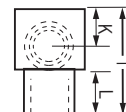
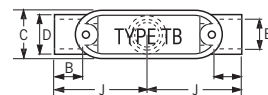
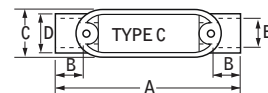
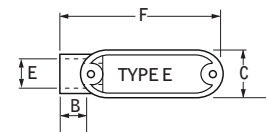
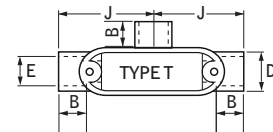
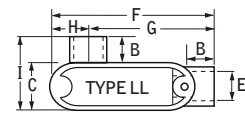
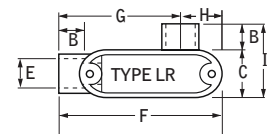
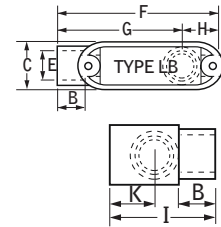

Size inches	G inches	H inches	I inches	J inches	K inches	L inches
-------------	----------	----------	----------	----------	----------	----------

Access Fitting Dimensions

1/2	4.1	1.3	2.5	2.3	1.0	0.8
3/4	4.1	1.3	2.5	2.8	1.0	0.8
1	4.8	1.5	2.1	3.3	1.1	1.1
1-1/4	5.8	1.8	3.6	4.0	1.6	1.0
1-1/2	6.5	1.8	3.9	4.3	1.7	1.1
2	8.2	2.3	4.5	5.4	2.0	1.2
2-1/2	9.8	3.8	6.2	7.3	2.6	-
3	10.9	2.7	6.2	7.3	2.6	-
3-1/2	11.5	4.5	7.5	8.5	3.0	-
4	11.5	4.5	7.5	8.5	3.0	-

All access fittings are CSA certified and UL listed for wet locations, except Type TB. Supplied with threaded brass inserts, combination brass head screws and PVC gasketing. Stainless steel screws are available upon request.





## ACCESS FITTINGS

	Hub Size inches	Part Number	Product Code
	1/2	SLB10S	077541
	3/4	SLB20S	077542
	1	SLB30S	077543
	1-1/4	SLB40S	077544
	1-1/2	SLB50S	077545
	2	SLB60S	077546
	2-1/2	SLB70S	077547
	3	SLB80S	077548
	3-1/2	SLB90S	077549
	4	SLB100S	077550

	Hub Size inches	Part Number	Product Code
	1/2	SLL10S	077521
	3/4	SLL20S	077522
	1	SLL30S	077523
	1-1/4	SLL40S	077524
	1-1/2	SLL50S	077525
	2	SLL60S	077526
	2-1/2	SLL70S	077527
	3	SLL80S	077528
	3-1/2	SLL90S	077530
	4	SLL100S	077529

	Hub Size inches	Part Number	Product Code
	1/2	ST10S	077461
	3/4	ST20S	077462
	1	ST30S	077463
	1-1/4	ST40S	077464
	1-1/2	ST50S	077465
	2	ST60S	077466
	2-1/2	ST70S	077467
	3	ST80S	077468
	3-1/2	ST90S	077571
	4	ST100S	077572

	Hub Size inches	Part Number	Product Code
	1/2	SLR10S	077481
	3/4	SLR20S	077482
	1	SLR30S	077483
	1-1/4	SLR40S	077484
	1-1/2	SLR50S	077485
	2	SLR60S	077486
	2-1/2	SLR70S	077480
	3	SLR80S	077488
	3-1/2	SLR90S	077487
	4	SLR100S	077489

	Hub Size inches	Part Number	Product Code
	1/2	SC10S	077501
	3/4	SC20S	077502
	1	SC30S	077503
	1-1/4	SC40S	077504
	1-1/2	SC50S	077505
	2	SC60S	077506
	2-1/2	SC70S	077507
	3	SC80S	077508
	3-1/2	SC90S	077510
	4	SC100S	077509

	Hub Size inches	Part Number	Product Code
	1/2	SE10S	077561
	3/4	SE20S	077562
	1	SE30S	077563
	1-1/4	SE40S	077564
	1-1/2	SE50S	077565
	2	SE60S	077566
	2-1/2	SE70S	077567
	3	SE80S	077568
	3-1/2	SE90S	077569
	4	SE100S	077570

	Hub Size inches	Part Number	Product Code
	1/2	STB10S	077451
	3/4	STB20S	077452
	1	STB30S	077453
	1-1/4	STB40S	077454
	1-1/2	STB50S	077455
	2	STB60S	077456

### "Two In One" Pull Elbow

The "two in one" access pull elbow reduces inventory costs (3/4" hub fitting supplied with 3/4" x 1/2" reducers). This pull elbow is approved for wet locations and provides for easy wire pulling.

### "Two In One" Pull Elbow

	Hub Size inches	Part Number	Product Code
	1/2 or 3/4	PE15/10	077491

All access fittings are CSA certified and UL listed for wet locations, except Type TB. Supplied with threaded brass inserts, combination brass head screws and PVC gasketing. Stainless steel screws are available upon request.

## SERVICE ENTRANCE FITTINGS

Scepter rigid PVC conduit is suitable for use in both overhead and underground service laterals. A complete range of non-corroding PVC service entrance fittings is available, including meter hubs, weather heads and meter offsets.

Size inches	Part Number	Product Code
-------------	-------------	--------------

### Service Entrance Fittings



1/2	EF10	077281
3/4	EF15	077282
1	EF20	077283
1-1/4	EF25	077284
1-1/2	EF30	077285
2	EF35	077286
2-1/2	EF40	077287
3	EF45	077288
3-1/2	EF50	077289
4	EF55	077290

Size inches	Part Number	Product Code
-------------	-------------	--------------

### Scepter PVC Expansion Joints (c/w TA fitting)

2	EJ35TA	077680
2-1/2	EJ40TA	077398
3	EJ45TA	077681
4	EJ55TA	077682

These special Scepter PVC expansion joints are supplied with the appropriately sized TA fitting. Assembled at the factory, the fittings are ready for installation directly to the meter socket. The installer needs only to 'set' the piston opening when connecting the underground raceway.

Size inches	Part Number	Product Code	A inches	B inches
-------------	-------------	--------------	----------	----------

### Long Meter Offsets Fabricated



1-1/4	LMO25	069641	12	0.92
1-1/2	LMO30	069645	12	1.69
2	LMO35	069646	14	1.52

Size inches	Part Number	Product Code
-------------	-------------	--------------

### Scepter Slip Meter Risers (c/w TA fitting)

2	SMR20TA	068371
2-1/2	SMR25TA	068372
3	SMR30TA	068373
4	SMR40TA	068374

Slip Meter Risers allow the underground PVC service conduit to 'slip' inside the fitting and thus account for ground movement. The factory assembled SMR fitting is supplied with a male adapter, is 2 feet in length and is sized to accept the underground raceway (i.e. 2" underground service conduit requires a 2" SMR). The SMR fitting must be installed with the open barrel end towards the ground.

Size inches	Part Number	Product Code
-------------	-------------	--------------

### Meter Offsets



1-1/4	MO25	077941
2	MO35	077942

### Meter Hubs

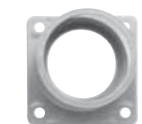

1-1/4	MHU25	077961
1-1/2	MHU30	077963
2	MHU35	077965
2-1/2	MHU40	077967
3	MHU45	077968

## BOXES - F SERIES

Our complete range of Scepter boxes and covers makes it easy to locate power and control precisely where you want it.

Scepter F-Series 3-in-1 PVC surface mount outlet boxes are available in single (deep), double and triple-gang configurations, with 1/2", 3/4" and 1" entry hubs all in one box. This innovative design enables contractors to reduce inventory, while ensuring they have the size they need when they need it.

With the exception of the FD, FD2 & FD3 Blank Boxes, Scepter F Series Boxes are molded with 1" conduit hubs and supplied with reducer bushings. The conduit hub(s) are field modified as 1/2", 3/4" or 1" to accommodate job-site requirements. The appropriate quantity of 1" x 3/4" and 3/4" x 1/2" reducers to create the desired hub size are packaged with each FD Series Single Gang Deep, Double Gang and Triple Gang Box.

All F Series boxes are supplied with integral mounting feet, threaded brass inserts and grounding screw.

Hub Size inches	Part Number	Product Code	Volume in <sup>3</sup>
-----------------	-------------	--------------	------------------------

### Single Gang Boxes

1/2	FSC10	077607	17.0
3/4	FSC15	077608	17.0
1/2	FS10	077601	17.5
3/4	FS15	077602	17.5
1/2	FSCC10	077622	16.3
3/4	FSCC15	077623	16.3
1/2	FSS10	077604	17.0
3/4	FSS15	077605	17.0

Note: 10 = 1/2" Hub, 15 = 3/4" Hub  
Outside Dimensions: Length, 4-9/16" - Width, 2-13/16" - Depth, 2"



FSC



FS



FSCC



FSS

### Single Gang Deep Boxes

1/2, 3/4, 1	FDC101520	077291	26.0
1/2, 3/4, 1	FDS101520	077299	26.8
BLANK	FD BLANK	077603	29.2
347 VOLT	FD347	077610	29.2

Note: 10 = 1/2" Hub, 15 = 3/4" Hub, 20 = 1" Hub  
Outside Dimensions: Height, 4 9/16" - Width, 2 13/16" - Depth 2 3/4",  
Cubic Inches = 35.30



FDC101520



FDS101520



FD Blank

## BOXES - F SERIES



### Universal Double Gang boxes – NEW Style

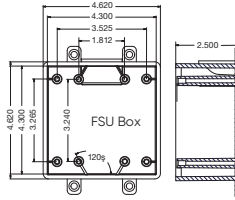

Hub Size inches	Part Number	Product Code
-----------------	-------------	--------------

1/2, 3/4, 1	FSU-2-101520	077364
1/2, 3/4, 1	FSCU-2-101520	077368
1/2, 3/4, 1	FSSU-2-101520	077372
1/2, 3/4, 1	FSCCU-2-101520	077369
Blank	FDU-2	077649

Note: FS-2 cu.in = 39.5, FSC-2 & FSS-2 cu.in. = 37.0, FSCC-2 cu.in. = 36.0

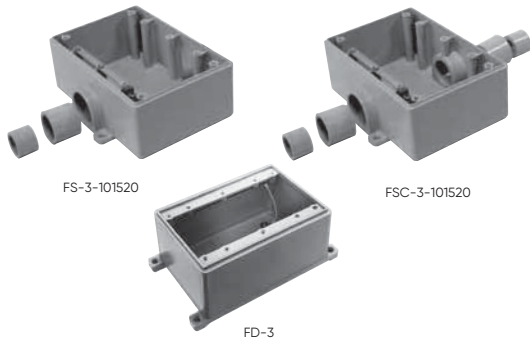
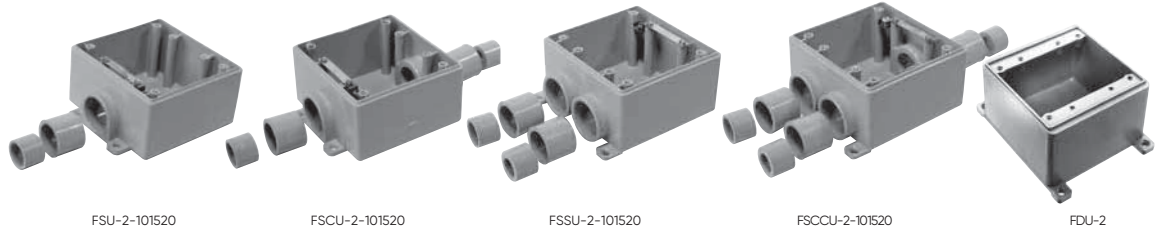

### Triple Gang Boxes

1/2, 3/4, 1	FS-3-101520	077337
1/2, 3/4, 1	FSC-3-101520	077438
Blank	FD-3	077737

Octagonal Boxes are shipped complete with cover, gasket, 4 reducing bushings (3/4" x 1/2"), and 4 sealing caps to be installed from inside box to seal off unused entry hubs.

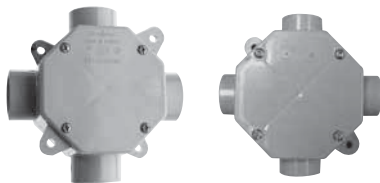

Size inches	Part Number	Hub Size inches	Product Code
-------------	-------------	-----------------	--------------

### Octagonal Boxes

4 x 1-1/2	OB15/10	1/2 - 3/4	077983
4 x 2-1/8	OB20	1	077984

Note: Octagonal Boxes are not designed for supporting light fixtures.

Size inches	Part Number	Product Code
-------------	-------------	--------------

### Octagonal Box Extension Rings

4 x 1 deep	XR20	077989
4 x 2 deep	XR35	077990



## COVER PLATES - F SERIES

Description	Part Number	Product Code
-------------	-------------	--------------

### Single Gang Plates

Duplex Receptacle	DRC15/10	077617
Toggle Switch	TSC15/10	077616
Single Receptacle	20RC15/10	077618
Single Receptacle	20-3RC15/10	077619
Single Receptacle	30-3RC15/10	077620
Blank c/w Gasket	BRC15/10	077611
PVC Gasket	GASK15/10	077621

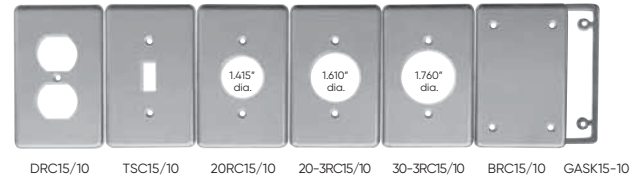

### Double Gang Plates - OLD Style

Blank Cover c/w Gasket	BRC20-2	077614
Double Switch	TSC20-2	077738
Double Duplex Receptacle	DRC20-2	077740
Combo Switch Duplex Receptacle	TSDC20-2	077739
PVC Gasket	GASK20-2	077743

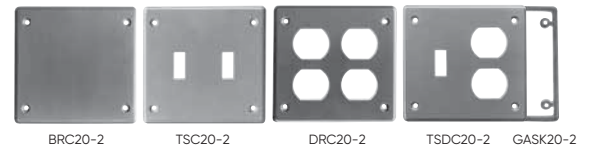

### Universal Double Gang Plates - NEW Style *(only fits new style double gang boxes)*

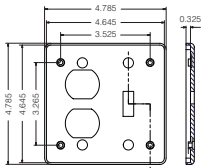

Blank Cover c/w Gasket	BRCU20-2	077359
Double Switch	TSCU20-2	077373
Double Duplex Receptacle	DRCU20-2	077362
Combo Switch Duplex Receptacle	TSDCU20-2	077374
PVC Gasket	GASKFU20-2	172650

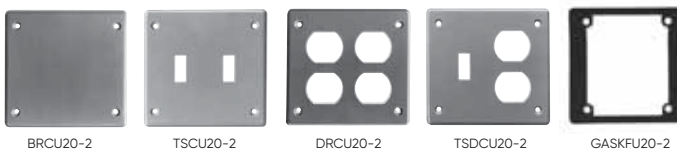

### Triple Gang Plates

Triple Receptacle	DRC20-3	077747
Combo Switch Receptacle	DSDR20-3	077745
Triple Switch	TSC20-3	077744
Combo Switch Receptacle	TSDC20-3	077746
Blank Cover c/w Gasket	BRC20-3	077748
PVC Gasket	GASK20-3	077749

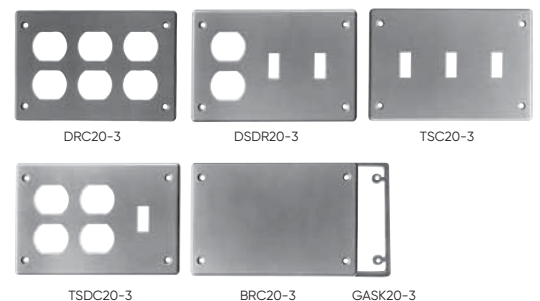

## WEATHERPROOF COVERS

Manufactured with stainless steel return-springs/clips and packaged with brass screws, Scepter weatherproof covers provide a positive seal, even in cold temperatures.

Description	Device Opening (in)	Part Number	Product Code
<b>Single Gang Weatherproof Covers</b>			
Plunger-style Switch Cover		VPT15/10	077630
Toggle Switch Cover		VSC15/10	077612
Grey Toggle Switch Cover		WTG15/10	077606
Grey Duplex Receptacle		WDR15/10	077993
White Duplex Receptacle		RWDR15/10	077786
Grey Ground Fault Receptacle		WGF15/10	077785
White Ground Fault Receptacle		RWGF15/10	077787
Single Receptacle Device 15 AMP	1.375	WTL15	077992
Single Receptacle Device 20 AMP	1.625	WTL20	077994
Single Receptacle Device 30 AMP	1.722	WTL30	077991
Single Receptacle Device 50 AMP	2.187	WTL50	077951
Grey Double Door Duplex Receptacle		WDRE15/10	077087
White Double Door Duplex Receptacle		RWDRE15/10	077408
Gasket for W Series Cover (except WDRE & RWDRE)		GASKW	077755
Gasket for WDRE & RWDRE Covers		GASKDD	072225

Gaskets are included with all weatherproof covers.



### Double Gang Weatherproof Covers – OLD Style

Toggle Switch Cover	VSC20-2	077741
Combination Switch Cover & GFI Receptacle	VSRC20-2	077742
Combination Switch Cover & Duplex Receptacle	VSDR20-2	077752
Combination Switch Cover & Single Receptacle	VSRR20-2	077753
Double Door GFCI Cover	VSGG20-2	077096
Double Door Duplex Cover	VSDD20-2	077097
Gasket for Double Gang (except VSGG20-2 & VSDD20-2)	GASK20-2	077743
Gasket for VSGG20-2 and VSDD20-2 Double Gangs	GASKV20-2	072227

Gaskets are included with all weatherproof covers.

VSGG20-2 and VSDD20-2 are universal and will fit on most PVC and metal boxes.

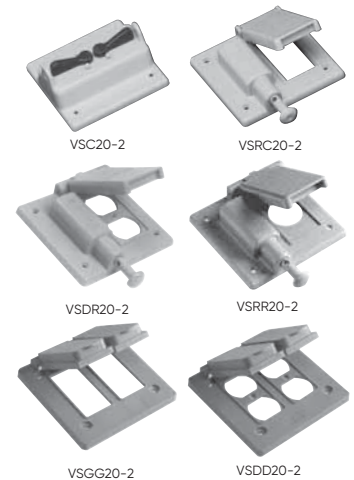

### Double Gang Weatherproof Covers – NEW Style *(only fits new style double gang boxes)*

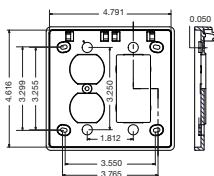

Toggle Switch Cover	VSCU20-2	077376
Combination Switch Cover & GFI Receptacle	VSRCU20-2	077357
Combination Switch Cover & Duplex Receptacle	VSDRU20-2	077356
Gasket	GASKFU20-2	172650

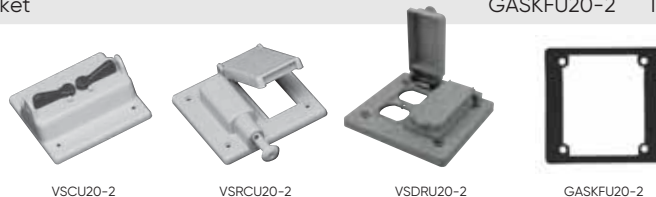

## SCEPTER PVC ROUND FLOOR BOX

Suitable for slab-on-grade, below grade and wood floor construction, Scepter PVC round floor boxes and accessories enable contractors to collectively run in-floor power, data and communications wiring to a single box for significant savings in time and materials.

Installation is quick and simple, with our nonmetallic floor box and covers, saving both time and money over similar metallic assemblies.

Scepter's floor box and duplex receptacle covers are constructed from high impact, noncorroding and nonconducting PVC. The flush-mount covers are available in custom colours and are shipped with a levelling ring complete with a grounding clip. Metal cover adapter kits are also available, allowing you to adapt to metal floor plates. Our 6" deep floor box allows flexibility for various concrete floor pours, while our 4-3/4" width offers easy access and ample wire room. The box comes complete with 2 - 1" and 2 - 3/4" hub openings.

All boxes are shipped complete with reducer plugs for added versatility.

Complete technical information available at [www.ipexelectrical.com](http://www.ipexelectrical.com) – Nonmetallic Floor Box & Accessories Technical Manual.

		Colour Description	Part Number	Product Code
	FB	Floor Box Base (includes disposable protective cap and reducer plugs)	FB	076954
	FBS-KIT	Floor Box Base c/w Leveling Ring Adapter (includes disposable protective cap, reducer plugs and leveling ring adapter)	FBKIT	077068
	FBS-KIT	Floor Box Stand Kit (includes FB Box) (is equipped with several height brackets which accommodate the different rebar and post-tension cable heights and slab depths found from job-site to job-site.)	FBS-KIT	077700
	AFMC	Metal Cover Adapter Kit (includes levelling ring, metal cover adapter and 2 gaskets)	AFMC	076953
	LRA-U	Universal Leveling Ring Adapter	LRA-U	076606
	FBDRC	Floor Box Duplex Receptacle Cover (Nonmetallic) (includes flush mount cover, blank cover & gasket)		
		Brown	FBDRCB	076943
		Gold	FBDRCG	076942
		Grey	FBDRCGr	076941
		Light Almond	FBDRCA	076940
	FBUDK	Tri-Service Universal Divider Kit (includes upper and lower dividers, riser tube and 2 grommets)	FBUDK	077948
	FBYC	Y Connector (3/4")	FBYC	077499

## BRASS AND NICKEL COVER PLATES

These cover plates help to protect enclosed power data and communications wiring from daily environmental floor conditions such as mopping (UL scrub water tested) and foot traffic (UL approved for cover loading).

The covers feature a light lacquer finish for extra strength and durability in high traffic areas and include a rubber gasket and aluminum backing plate to create a water-tight seal. The flush mount cover plates should be installed to the floor box using the LRA-U.

Description	Part Number	Product Code
-------------	-------------	--------------

### Nickel Cover Plates

Duplex Receptacle Cover with Dual Flip Lid	DFL-2-N	178279
Duplex Receptacle Cover with Individual Screw Plug Openings	SSC-N	178278
Combination 2" x 1/2" Single Screw Plug Opening	DSC-N	178280



DFL-2-N



SSC-N



DSC-N

### Brass Cover Plates

Duplex Receptacle Cover with Dual Flip Lid	DFL-2	178096
Duplex Receptacle Cover with Individual Screw Plug Openings	SSC	178093
Combination 2" x 1/2" Single Screw Plug Opening	DSC	178091
Combination 2" x 1/2" Single Screw Plug and 1/2" Datacomm Opening	DSC-P/C	178092



DFL-2



SSC



DSC-N



# JUNCTION BOXES

## Fabricated Boxes

Unflanged PVC fabricated boxes of any size may be made to customers' specifications and come complete with lids, gaskets and screws. These boxes are not CSA Certified and are not returnable.

Scepter's JB FLANGED 'H' SERIES JUNCTION BOXES provide H10 Highway Loading equivalent to handling a 50 psi load. The fiber-reinforced safety tread cover secures using recessed Hex Key fastening hardware offering a simple installation while reducing the opportunity for tampering.

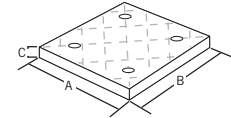
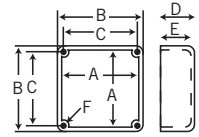

Part Number	Product Code	Box ID (inches)			Lid Dimensions (inches)			Volume (in <sup>3</sup> )
		L	W	D	A	B	C	

## Flanged Box w Fire-reinforced Safety Tread Cover

H664	077685	6	6	4-1/4	9.0	9.0	0.60	138.0
H666	077686	6	6	6-1/4	9.0	9.0	0.60	211.0
H884	077687	8	8	4-1/4	11.5	11.5	0.75	248.0
H886	077688	8	8	6-1/4	11.5	11.5	0.75	434.0
H887	077689	8	8	7-1/4	11.5	11.5	0.75	434.0
H887-A	077692	8	8	7-1/4	11.5	11.5	0.75	434.0

H887

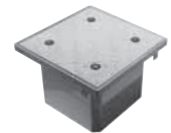

H887-A

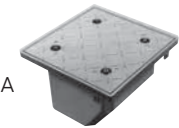

Size (inches)	Part Number	Product Code	ID	OD (inches)	L	OL
---------------	-------------	--------------	----	-------------	---	----

## Junction Box Adapters

1/2	JBA10	077721	0.62	1.20	0.81	0.95
3/4	JBA15	077722	0.79	1.40	0.87	1.01
1	JBA20	077723	1.00	1.58	0.89	1.06
1-1/4	JBA25	077724	1.35	1.98	1.12	1.30
1-1/2	JBA30	077725	1.59	2.37	1.10	1.33
2	JBA35	077726	2.05	2.85	1.25	1.54
2-1/2	JBA40	077727	2.45	3.34	1.68	1.99
3	JBA45	077728	3.05	3.10	1.77	2.11
3-1/2	JBA50	077729	3.54	4.50	2.09	2.41
4	JBA55	077730	4.02	5.03	1.99	2.30

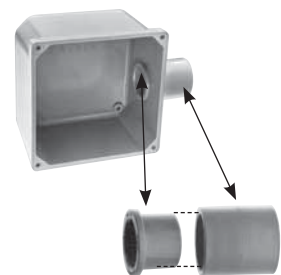
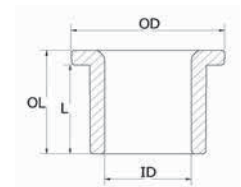

Junction Box Adapter Standard PVC Coupling

**NEW  
HINGED COVER**

# The RIGHT BOX for the RIGHT Environment



**Scepter®**  
**JBox™**  
The Next Generation Junction Box

**The Scepter® JBox™ has a new feature... the Hinged Cover.** Designed to work with your existing PVC conduit runs, the Scepter JBox Hinged Cover opens more than 180° for complete and easy access to control devices and instruments. NEMA 3R and 4X rated, the Scepter JBox Hinged Cover is ideally suited for indoor and outdoor use, in wash-down environments and includes all the features that contractors have come to appreciate in the new Scepter JBox.

VISIT [www.ipexna.com](http://www.ipexna.com)

NEMA Rated 1, 2, 3R, 4, 4X, 12 & 13



UL 50 / CSA C22.2 No. 94.1 | UL 50E / CSA C22.2 No. 94.2  
CSA C22.2 No. 40 | CSA C22.2 No. 85

The Scepter® JBox™ is ideally suited for indoor and outdoor use and made to perform in the most demanding environments. Made of PVC it is extremely durable and resistant to impact in a wide range of temperatures and not adversely affected by water and chemicals. Built for tough wet corrosive environments, the Scepter® JBox™ is entirely non-metallic, eliminating corrosion concerns with screws and other metal parts.

A real time-saver, the "close-by-hand – tool-assist to open" fasteners are functional and resilient as they are made of a performance grade thermoplastic polyester resin, Valox. The impact modified and UV stabilized Valox material provides exceptional mechanical and thermal properties along with excellent chemical resistance.

# Next Generation Junction Box



Scepter JBox

30



Scepter JBox with Hinged Cover

33

# SCEPTER JBOX

4" - 16" (100mm - 400mm)

## Scepter® JBox™

Scepter® JBox™, the Next Generation Junction Box. The original junction box is completely redesigned and new features have been added to make this the easiest box to use. The patent pending integral gasket, non-metallic fasteners, molded mounting feet, embossed grid-lines and flat cover features have been engineered to provide a contractor-friendly junction box.

### ADVANTAGES

- 1 Zero Footprint**  
Design allows for installation in corners and immediately adjacent to other products. There is easy access to all mounting feet and fasteners.
- 2 Installing Overhead**  
Integral fasteners allow for easy overhead positioning and securing.
- 3 Mounting in a Cover**  
Pilot lights, control switches and other devices are easily mounted. The Cover is free and clear of supporting ribs, and has a uniform thickness.
- 4 Added Security**  
Sizes 6" and larger feature a lock-out option. Tie-wrap, tamper resistant bolt or padlock will restrict access to the box.
- 5 More Interior Volume**  
Increased space from wire pulling and for ease of bend radius. The increased cubic inch volume allows for more flexibility

### APPLICATIONS

- Corrosive environments
- Waste-water treatment facilities
- Marine & car washes
- Agricultural
- Wash down

### STANDARDS

NEMA Rated  
1, 2, 3R, 4, 4X, 6\*, 6P\*, 12, 13  
\*Applies only to 4" to 12" non-hinged covers

CSA Listed  
CSA C22.2 No. 40  
CSA C22.2 No. 85  
UL 50 / CSA C22.2 No. 94.1  
UL 50E / CSA C22.2 No. 94.2



### SHORT FORM SPECIFICATIONS

Junction boxes shall be acceptable for indoor and outdoor use and manufactured of PVC in a gray colour analogous to Rigid PVC conduit and fittings. The junction box and its fasteners, hinges or components shall be entirely non-metallic. Boxes shall be NEMA rated and certified to bi-national standard UL50/50E – CSA No.94.1/94.2 by a Nationally Recognized Testing Laboratory (i.e. UL or CSA).

The cover/box gasket shall be dual-molded or permanently fixed so as to be an integrated part of the cover. The cover should be secured to the box using non-metallic quarter-turn

"close by hand, tool assist to open" fasteners. To aid in the alignment and proper positioning of conduit connections the box/enclosure shall have embossed gridlines on the sidewalls. The mounting feet shall be a permanent molded feature of the box and not extend beyond the periphery of the box/enclosure. On boxes/enclosures of nominal size 6" x 6" and larger, back-panel / DIN rail mounting and pad-lock provisions shall be incorporated into the product.

Acceptable manufacturer: IPEX (Scepter JBox Series)

### SMOOTH FLAT COVER

- No ribs – offers a flat, smooth surface for mounting of devices or labels
- No engravings

### HAND-CLOSE FASTENERS

- Close by hand – tool assist to open
- 100% non-metallic – corrosion resistant material
- No loose hardware for easy installation

### LOCK-OUT OPTION

- Available on sizes 6" to 16"
- Use a tie-wrap, bolt or padlock for added security

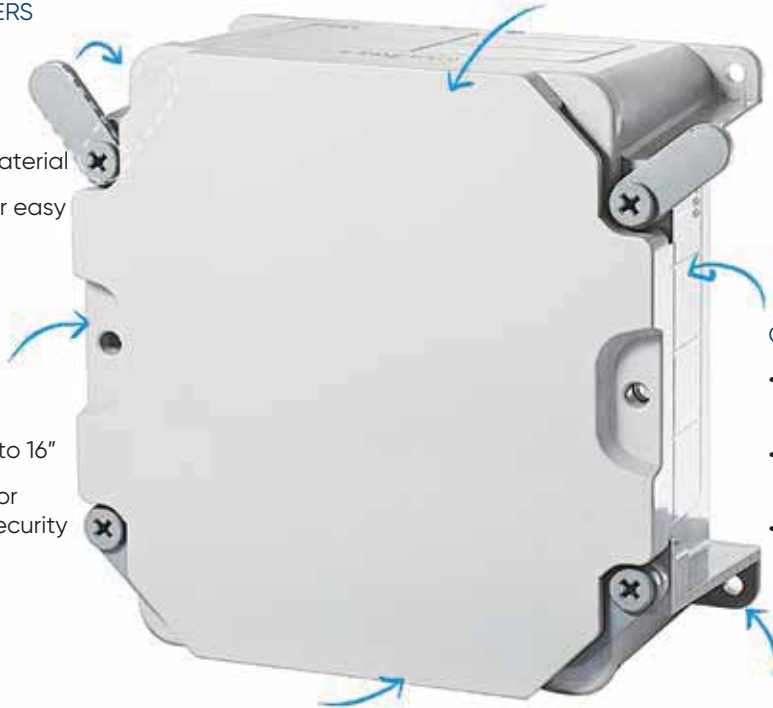

### GRIDLINES FOR DRILLING

- Easy reference for drilling knockouts
- Makes conduit alignment a snap
- Indicates a "drill zone"

### INTEGRATED GASKET

- Injection molded and extruded gaskets permanently fixed to the cover – no installation required
- Proprietary gasket material creates a 6P rated enclosure (4" – 12")
- Neoprene gasket material creates a 4X rated enclosure (14" – 16")

### MOLDED MOUNTING FEET

- Molded – no loose parts to assemble
- Located on corners out of the way of conduit connections
- Flush with the back of the box for close surface mounting
- Integrated design of mounting feet offers improved strength

### POLE MOUNTING KIT

- Installs on round, square & octagonal poles up to 15" diameter
- Works with wood, concrete, steel and composite poles
- Supplied as a complete kit in galvanized or stainless steel

### BACK PANEL

- Designed to fit sizes 6" and 16"
- Made of 14 gauge carbon steel
- White epoxy powder-coated finish
- Easy to cut and drill to mount devices

## SCEPTER JBOX 4" TO 6"

Size inches	Part Number	Product Code	L1	W1	L2	W2	H	M1	M2	G1	G2	J1	J2	D	K
4x4x2	JBX442	277000	4.97	3.93	3.48	3.48	2.90	4.48	3.44	2.41	1.09	1.72	1.09	0.51	0.24
4x4x4	JBX444	277001	4.90	3.86	3.48	3.48	4.89	4.41	3.37	2.22	2.97	1.59	2.97	0.59	0.24
5x5x2	JBX552	277002	5.97	4.93	4.55	4.55	2.90	5.48	4.44	3.41	1.09	2.69	1.09	0.51	0.24
6x3x4	JBX634	277003	3.90	5.86	2.48	5.48	4.89	3.41	5.37	1.22	2.72	3.42	2.72	0.59	0.28
6x6x4	JBX664	277004	7.58	7.58	5.86	7.20	4.90	6.90	6.90	4.47	2.47	4.47	2.47	0.59	0.28
6x6x6	JBX666	277005	7.51	7.51	5.79	7.13	6.90	6.83	6.83	4.22	4.47	4.22	4.47	0.72	0.28

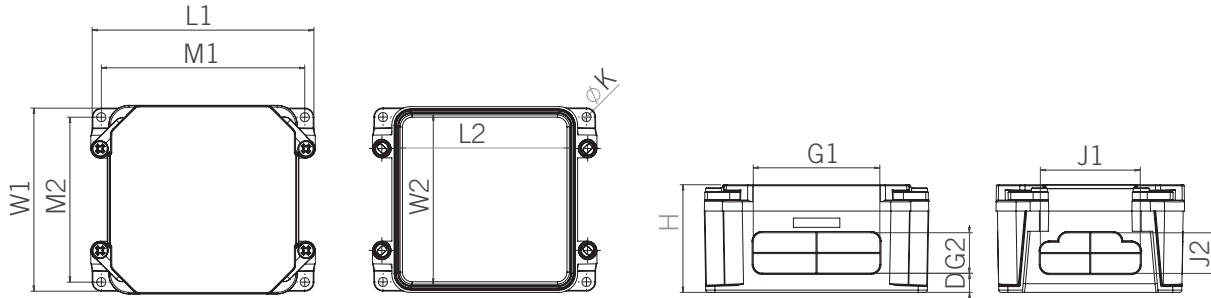

JBX8442 - JBX444

## SCEPTER JBOX 8" TO 16"

Size inches	Part Number	Product Code	L1	W1	L2	W2	H	M1	M2	G1	G2	N1	N2	P1	P2	D	K
8x8x4	JBX884	277006	9.58	9.58	7.86	9.20	4.90	8.90	8.90	6.47	1.97	8.25	6.26	3.94	3.13	0.59	0.28
8x8x7	JBX887	277007	9.47	9.47	7.76	9.10	7.90	8.80	8.80	6.22	4.65	8.25	6.26	3.94	3.13	0.75	0.28
12x12x4	JBX12124	277008	13.58	12.24	11.74	11.74	4.90	12.90	11.56	9.28	2.03	10.26	10.25	3.94	3.13	0.56	0.28
12x12x6	JBX12126	277009	13.51	12.17	11.74	11.74	6.90	12.83	11.49	9.03	3.78	10.26	10.25	3.94	3.13	0.67	0.28
12x12x8	JBX12128	277010	13.44	12.10	11.74	11.74	8.90	12.76	11.42	8.81	5.64	10.26	10.25	3.94	3.13	0.76	0.28
14x14x8	JBX14148	277011	15.72	14.39	13.80	13.80	9.10	15.10	13.70	11.05	5.69	12.25	10.26	3.94	3.16	0.83	0.33
14x14x10	JBX141410	277012	15.66	14.32	13.80	13.80	11.10	14.98	13.64	11.05	7.55	12.25	10.26	3.94	3.16	0.83	0.33
16x16x10	JBX161610	277013	17.64	16.30	15.71	15.71	11.10	17.00	15.60	12.55	7.55	14.25	12.26	4.71	4.09	0.83	0.33

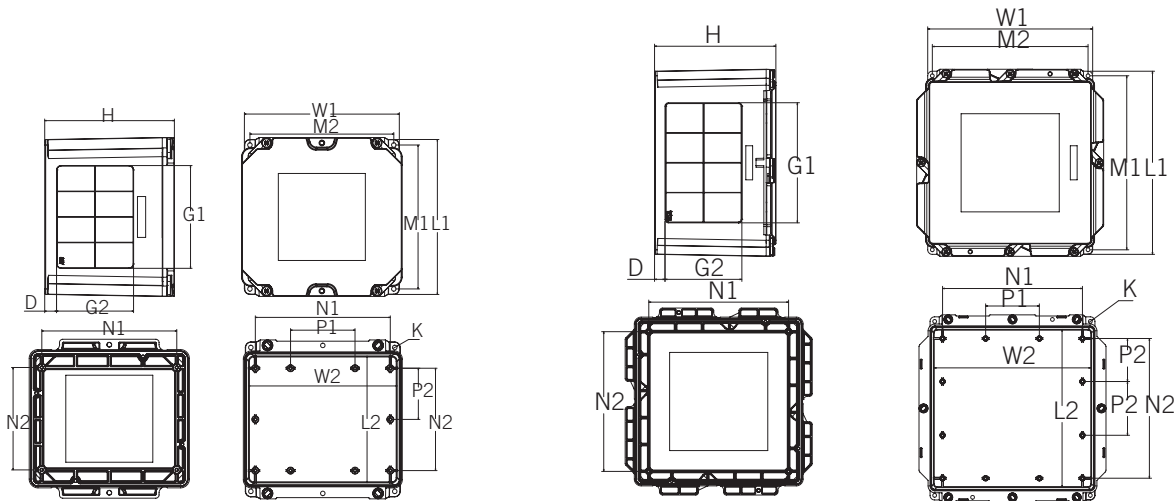

JBX884 - JBX887

JBX12124 - JBX161610

## SCEPTER JBOX WITH HINGED COVER

The new Hinged Cover opens up to 214° and are removable for complete and easy access to control devices and instrumentation.

The Scepter JBox Hinged Cover is NEMA 3R and 4X rated, ideally suited for indoor and outdoor industrial, MRO and OEM applications, and in wash-down environments. It is 100% non-metallic and includes all the features that users have come to appreciate in the Scepter JBox.



## SCEPTER JBOX HINGED COVER

Size inches	Part Number	Product Code	L1	W1	L2	W2	H	M1	M2	G1 inches	G2	N1	N2	P1	P2	D	K
8x8x4	JBXH884	277100	9.58	9.58	7.86	9.2	4.9	8.9	8.9	6.47	1.97	8.25	6.26	3.94	3.13	0.59	0.28
8x8x7	JBXH887	277101	9.47	9.47	7.86	9.2	7.9	8.9	8.9	6.22	4.65	8.25	6.26	3.94	3.13	0.75	0.28
12x10x6	JBXH12106	277102	11.51	12.17	9.67	11.67	6.9	10.8	11.49	8.03	3.78	10.25	8.26	3.94	2.16	0.67	0.28
12x12x4	JBXH12124	277103	13.58	12.24	11.74	11.74	4.9	12.9	11.56	9.28	2.03	10.26	10.25	3.94	3.13	0.56	0.28
12x12x6	JBXH12126	277104	13.51	12.17	11.74	11.74	6.9	12.83	11.49	9.03	3.78	10.26	10.25	3.94	3.13	0.67	0.28
12x12x8	JBXH12128	277105	13.44	12.10	11.74	11.74	8.9	12.76	11.42	8.81	5.64	10.26	10.25	3.94	3.13	0.76	0.28
14x14x8	JBXH14148	277106	15.72	14.39	13.80	13.80	9.1	15.10	13.70	11.05	5.69	12.25	10.26	3.94	3.16	0.83	0.33
14x14x10	JBXH141410	277107	15.66	14.32	13.80	13.80	11.1	14.98	13.64	11.05	7.55	12.25	10.26	3.94	3.16	0.83	0.33
16x16x10	JBXH161610	277108	17.64	16.30	15.71	15.71	11.1	17.0	15.60	12.55	7.55	14.25	12.26	4.71	4.09	0.83	0.33

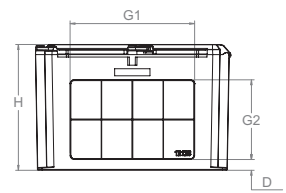
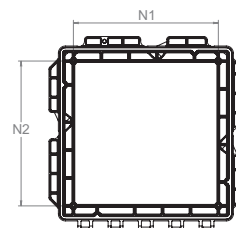
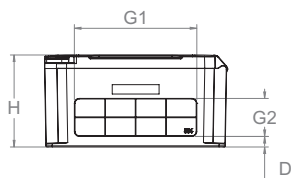
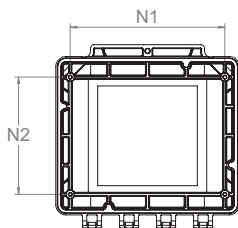
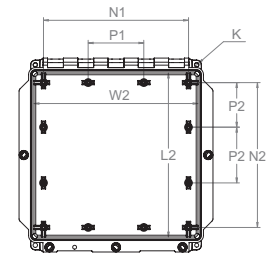
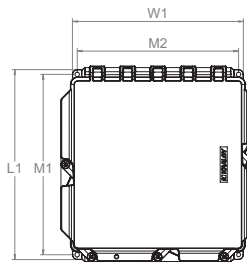
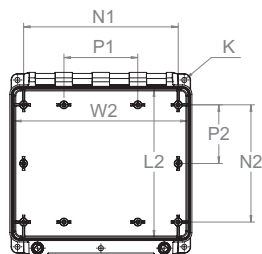
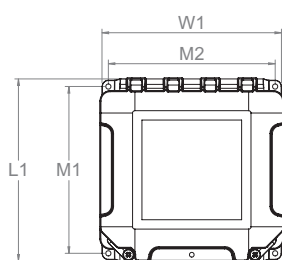

JBXH884 - JBXH887

JBXH12106 - JBXH161610

## POLE MOUNTING KIT

- Available in either galvanized or stainless steel (SS)
- Supplied as complete kits (sold separately)
- Works with wood, concrete, steel and composite poles
- Installs on round, square & octagonal poles up to 15"

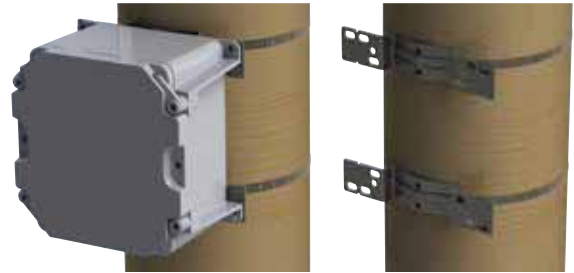

Description	Fits JBox	Part Number	Product Code
Pole Mount Kit	4" to 12"	PMK4-12	077940
Pole Mount Kit – SS	4" to 12"	PMK4-12SS	077946
Pole Mount Kit – SS	14" to 16"	PMK14-16SS	277086

## BACK PANELS

- Made of 14 gauge carbon steel
- White epoxy powder-coated finish
- Easy to cut and drill to mount devices



Size inches	Part Number	Product Code	W	H	A	B	C
6x6	BP66CSW	077864	4.88	6.75	4.26	6.25	0.25
8x8	BP88CSW	077861	6.88	8.75	6.26	8.25	0.25
12x10	BP1210CSW	077862	8.88	10.75	8.26	10.25	0.25
12x12	BP1212CSW	077865	10.88	10.75	10.26	10.25	0.25
14x14	BP1414CSW	077867	10.88	12.75	10.26	12.25	0.25
16x16	BP1616CSW	077868	12.88	14.75	12.26	14.25	0.25

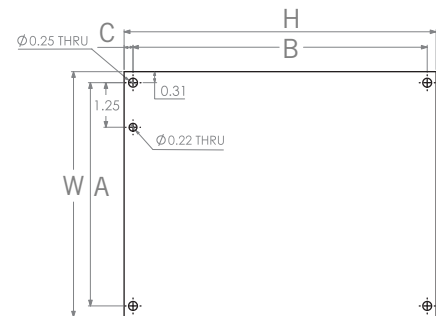



## SCEPTER JBOX PERFORMANCE RATINGS

**MAXIMUM TEMPERATURE RANGE:** Maximum ambient temperatures to 122°F (50°C) as per the NEC

**RECOMMENDED OPERATING TEMPERATURE:** -40°F to 122°F (-40°C to 50°C)

**UV AND WATER EXPOSURE RATING:** UL 746C approved for exposure to UV and water

**FLAME & SMOKE RATING:** UL 94V-0 (UL94 Vertical Flame Test)

**NEMA ENCLOSURE RATINGS:** The Scepter JBox is NEMA Rated 1, 2, 3R, 4, 4X, 6\*, 6P\*, 12, 13 (\*Applies only to sizes 4" to 12")

**INDUSTRIAL CONTROL PANELS UL 508A:** Suitable to be used as an enclosure per section 18 of UL 508A

**CONDUCTORS:** Suitable for use with 90°C Rated Conductors

### NEMA RATING

Type	Description
1	Enclosures for indoor use providing protection from contact with the enclosed equipment and ingress of solid objects (falling dirt).
2	Enclosures for indoor use providing protection from contact with the enclosed equipment, ingress of solid objects (falling dirt) and from harmful effects on equipment due to ingress of water (dripping and light splashing)
3R	Enclosures for indoor or outdoor use providing protection from contact with the enclosed equipment, ingress of solid objects (falling dirt) and from harmful effects on equipment due to ingress of water (rain, sleet, snow) and is undamaged by the external formation of ice.
4	Enclosures for indoor or outdoor use providing protection from contact with the enclosed equipment, ingress of solid objects (falling dirt and windblown dust) and from harmful effects on equipment due to ingress of water (rain, sleet, snow, splashing water and hose directed water) and is undamaged by the external formation of ice.
4X	Enclosures for indoor or outdoor use providing protection from contact with the enclosed equipment, ingress of solid objects (windblown dust) and from harmful effects on equipment due to ingress of water (rain, sleet, snow, splashing water and hose directed water), protection against corrosion and is undamaged by the external formation of ice.
6	Enclosures for indoor or outdoor use providing protection from contact with the enclosed equipment, ingress of solid objects (falling dirt) and from harmful effects on equipment due to ingress of water (hose directed water and entry of water on occasional temporary submersion at a limited depth) and is undamaged by the external formation of ice.
6P	Enclosures for indoor or outdoor use providing protection from contact with the enclosed equipment, ingress of solid objects (falling dirt) and from harmful effects on equipment due to ingress of water (hose directed water and entry of water during prolonged submersion at a limited depth) and is undamaged by the external formation of ice.
12	Enclosures for indoor use providing protection from contact with the enclosed equipment, ingress of solid objects (falling dirt circulating dust, lint, fibers and flyings) and from harmful effects on equipment due to ingress of water (dripping and light splashing).
13	Enclosures for indoor use providing protection from contact with the enclosed equipment, ingress of solid objects (falling dirt circulating dust, lint, fibers and flyings) and from harmful effects on equipment due to ingress of water (dripping and light splashing) and against the spraying, splashing and seepage of oil and non-corrosive coolants.

NOTE: The Scepter JBox Hinged Cover is NEMA Rated for 1, 2, 3R, 4, 4X, 12 & 13



# Conduit REPAIR QUICK & EASY!

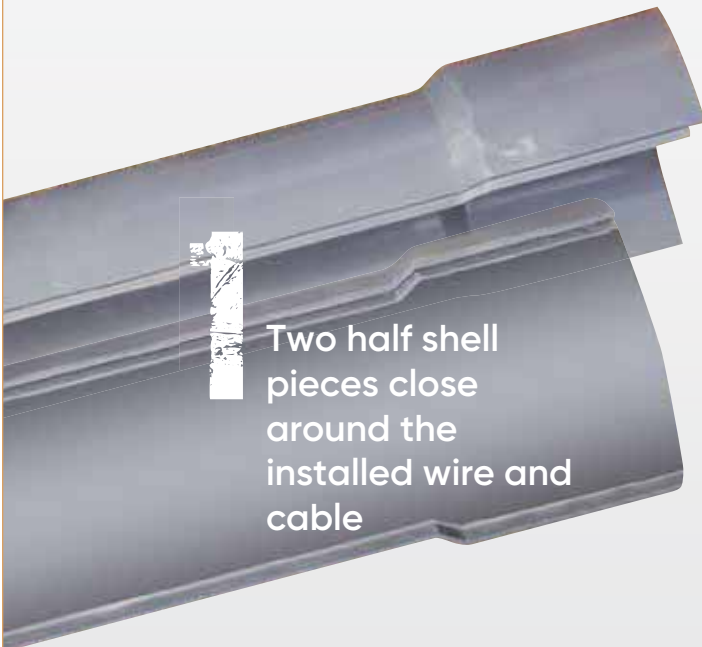

1

Two half shell pieces close around the installed wire and cable



2

Interlocking joints provide water-tight seal



3

Standard PVC solvent cement quickly connects the EPR kit, restoring the conduit to its original form

## FEATURES & BENEFITS

- Restores structural integrity of conduit system
- Cost savings with fast and easy installation
- Compatibility with existing installed PVC conduit

1. Two half shell pieces close around the installed wire and cable.
2. Interlocking joints provide water-tight seal.
3. Standard PVC solvent cement quickly connects the EPR kit, restoring the conduit to its original form.

# Conduit Repair



EPR Conduit Repair Kit

# EPR REPAIR KITS

1-1/4" - 6" (30mm - 150mm)



These clever and innovative conduit repair kits from IPEX are the first total repair systems for broken and damaged PVC conduit. They offer fast and easy repairs for damaged conduit caused by actions such as earth excavation, horizontal and core drilling.

With unique interlocking joints, the EPR Kits' two half shell bell by bell pieces simply close around the installed wire and cable. Using standard PVC solvent cement, EPR Kits are quickly and easily assembled and connected, restoring the conduit to its original form. And, unlike other conduit repair systems, EPR Kits are capable of repairing various lengths and types of pipe quickly and accurately, saving you time and money.

## ADVANTAGES

- 1 Restores structural integrity of conduit system
- 2 Cost savings with fast and easy installation
- 3 Compatibility – inside diameter of bell equals outside diameter of pipe to create a bell and spigot connection
- 4 Special interlocking joints provide water-tight seal
- 5 Packaging includes easy to follow instruction sheet
- 6 Ideal for the repair of rigid PVC conduit in electrical, telecommunication, utility and CATV applications

REPAIRS CONDUIT AS EASY AS 1-2-3

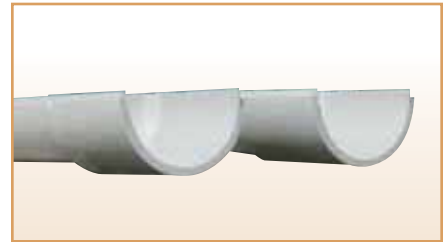

### EPR KIT FOR CONDUIT REPAIR

Size (in)	Part Number	Product Code	Length (in)
1-1/4	EPR25	077982	24
1-1/2	EPR30	077981	24
2	EPR35	077980	24
2-1/2	EPR40	077960	24
3	EPR45	077958	24
4	EPR55	077957	24
5	EPR60	077956	24
6	EPR65	077955	24

### EPR KIT ADAPTER FOR DUCT REPAIR

Size (in)	Part Number	Product Code	UPC	Standard Pkg
2	EPRA35	077852	622454380233	80
3	EPRA45	077853	622454380240	20
4	EPRA55	077854	622454380257	20
5	EPRA60	077855	622454380264	4
6	EPRA65	077856	622454380271	4

\* Item sold separately from the EPR Kit.





## SAVE Time & Money with Cor-Line ENT & Kwikon Fittings



### An ENT system you can count on!

In 1986 we made in-slab electrical raceways faster to install by introducing the industry's first true, integrated ENT system – long lengths of flexible tubing that reduce the number of couplings needed. Cor-Line tubing and Kwikon fittings are designed to work together and provide the most robust concrete-tight ENT system on the market.

- Strong and flexible ENT tubing
- Six locking tabs for unbreakable connections
- Boxes are installation ready and concrete-tight
- Form stubbies eliminate the need to drill to the deck
- Labour saving design compared to traditional EMT



### Kwikon Slab Boxes... Installation Made Easy

- Approved for support of ceiling fans up to 35 lbs and luminaries up to 50 lbs
- **NEW** corner mounting tabs to guide nails inside the trim area
- **NEW** Clear Vue vacuum formed, removable covers allow markings to be seen and prevent slur or stucco from entering the box
- Ready to install – no assembly required

We designed Cor-Line® Electrical Nonmetallic Tubing (ENT), and Kwikon® fittings, slab boxes and accessories with two goals. Firstly, we set out to create an integrated ENT system tough enough to meet the rugged day-to-day challenges of the construction industry. More importantly, we wanted to make a system that saves time and money on the job site. People who work with it daily insist we got it right on both counts.

The best alternative to heavy and labor-intensive 10 ft. lengths of metal conduit, Cor-Line was made for fast, easy installation, saving valuable man-hours on any construction site.

As the toughest non-corroding, non-conducting ENT system on the market, its durability – even under tons of concrete – ensures years of reliable use for savings over the long run.

Saving contractors time, money and worry, this integrated ENT system makes sure the job gets done right.

# Nonmetallic Tubing & Fittings



Cor-Line ENT

42

Kwikon Fittings

42



# COR-LINE ENT & KWIKON FITTINGS

1/2" - 2-1/2" (12mm - 65mm)



Noncorroding and nonconducting Cor-Line® Electrical Nonmetallic Tubing (ENT) and Kwikon® fittings, slab boxes and accessories are engineered for the rugged day-to-day challenges of the construction industry - whether encased in concrete, concealed in walls or ceilings, or in direct burial applications.

Cor-Line ENT's corrugated construction allows it to be bent easily by hand. No special bending equipment is required. And our patented Kwikon couplings and connectors, with their unique 360° locking tabs, provide for snap-on, lock-in installation that exceeds CSA and UL requirements for conduit pullout.

Add our innovative form stubbys and Kwikon concrete-tight slab boxes, (available with or without integral 1/2", 3/4" or 1" molded hub connectors) and you've got a total integrated system that saves you time and money on the job. Available in 1/2" to 2" sizes, Cor-Line ENT is FT-4 rated for use in non-combustible construction.

## ADVANTAGES

- 1 Concrete-Tight**  
Every contractor's worst nightmare is a product that doesn't work or hold up in poured concrete; the costs of replacement and repair can be tremendous. Cor-Line ENT and Kwikon fittings are concrete-tight, requiring no solvent welding or tape around the connections, or paper stuffed inside.
- 2 Pull Resistant**  
Once a length of Cor-Line tubing is connected to a coupling or connector, it stays connected, thanks to our unique six locking tab design. With a pull-out resistance of up to 175 lbs., our patented snap-on, lock-in system provides a seal that easily meets CSA requirements for conduit pullout.
- 3 Fire Resistant**  
Cor-Line ENT tubing and Kwikon fittings and slab boxes are approved for use in noncombustible 2 hour and 4 hour fire-rated floor/ceiling assemblies.
- 4 Impact Resistant**  
Cor-Line ENT is made of impact resistant PVC, so it won't break or crack if an object is dropped on it or someone steps on it.
- 5 Strong Fittings**  
Kwikon's strong, solid fittings meet all CSA requirements.
- 6 Flexible**  
Flexible enough to be bent by hand, Cor-Line ENT is tough enough to withstand crushing and breaking.

## APPLICATIONS

- Residential (low or high rise)
- Commercial (low or high rise)
- Institutional (Prisons, Schools, Universities)
- Hospitals and Nursing Homes
- Stadiums and Arenas

## STANDARDS



CSA Standards C22.2

NEMA TC-13

## STORAGE & HANDLING

- NOT to be installed, stored, or handled in cold temperatures below -20°C (-4°F)
- NOT to be stored outside



## DID YOU KNOW?

With its concrete-tight design and easy-to-install angled stubbies, Cor-Line and Kwikon offer the perfect ENT solution for inslab floors.

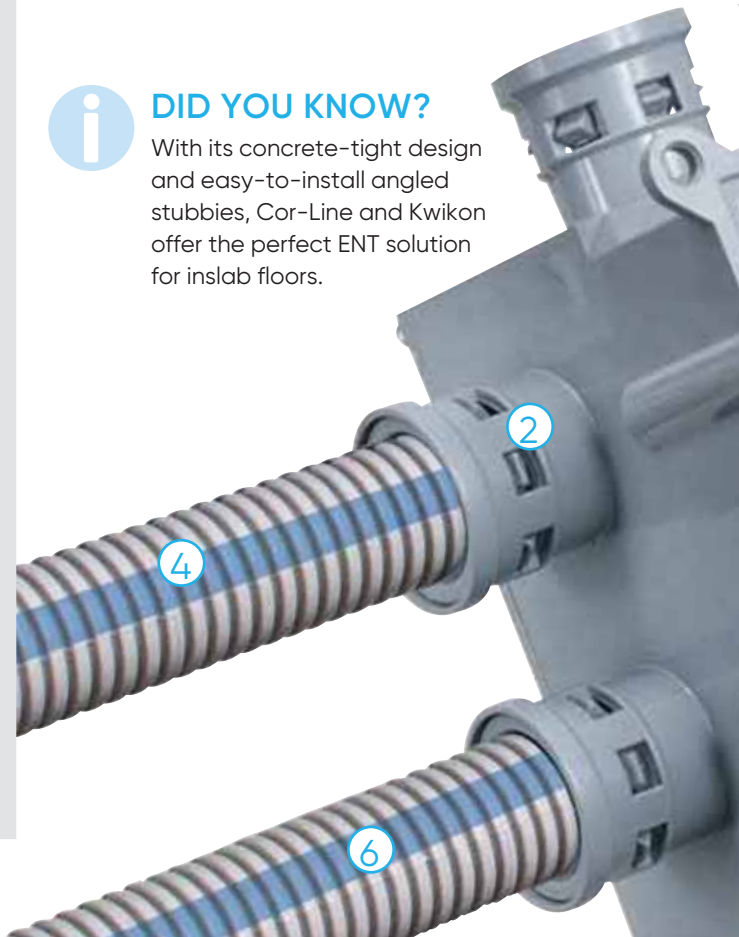



## INSTALLING IS THIS EASY

### 1. Unroll Cor-Line to desired length

Available in convenient coil and reel lengths up to 1,500 ft., Cor-Line gives you the flexibility to measure out exactly the amount of tubing you need. Cor-Line requires fewer couplings for long spans than metal conduit. It's recommended ENT be securely fastened at 2 – 3 ft. intervals.

### 2. Cut Cor-Line with an Ent Cutter

For straight cuts every time use the Kwikon scissor-style cutting tool. However, no special tools or cutting equipment are necessary. Cor-Line can even be cut with a standard utility knife.

### 3. Make bends and turns by hand

Unlike metal which has to be cut to fit tight spaces, Cor-Line can be bent, turned and manipulated by hand to wind around irregular curves and corners. When bending, ensure the radius of the curve is at least six times the diameter of the tubing.

### 4. Simply snap connections together

With no special tools or equipment needed, Kwikon's unique snap-on fittings quickly and easily join or terminate Cor-Line ENT and provide a concrete-tight connection.

### 5. Pull Cable through Cor-Line

Cor-Line's interior corrugated surface significantly reduces the amount of friction when pulling cables through long runs, even in runs with 90° bends. With Cor-Line, you can pull longer runs of cable without worrying about damage.



## SHORT FORM SPECIFICATIONS

### GENERAL

#### 1.1 References

- A. Standards referred to in this section are:
  1. CSA Standards C22.2, No. 227.1 and C22.2 No. 85.
  2. NEMA TC-13 Electrical Nonmetallic Tubing.

### PRODUCTS

#### 2.1 Manufacturers

- A. Acceptable manufacturers are listed below
  1. Electrical Nonmetallic Tubing:
    - a. Cor-Line by IPEX
  2. Electrical Nonmetallic Tubing Fittings:
    - a. Kwikon by IPEX
  3. Electrical Nonmetallic Tubing Boxes:
    - a. Kwikon by IPEX
- B. All ENT tubing, ENT fittings, ENT boxes and accessories shall be manufactured by the same company so as to form a complete ENT system.
- C. ENT systems shall be approved for use in fire resistance rated concrete floor-ceiling assemblies with fire resistance ratings up to 4 hours.

#### 2.2 Raceways

- B. ENT raceway shall be listed to CSA C22.2 No. 227.1 and manufactured in accordance with NEMA TC-13.

#### 2.3 Fittings

- A. ENT Fittings shall be manufactured of high-impact PVC,
- B. ENT Fittings shall meet the following requirements:
  1. Six locking tabs located every 60° providing 360° contact.
  2. Locking tabs shall provide a conduit pullout of a minimum 175 ft-lb force.
  3. Concrete tight without the need for taping.
  4. When transitioning to EMT conduit, the transition fitting shall have six locking tabs for ENT connection and set-screw connection for EMT.

#### 2.4 Boxes

- A. ENT boxes shall be manufactured of high-impact PVC,
- B. ENT Slab Box and Wall Box requirements:
  1. Slab Boxes shall be approved for the purpose and concrete-tight.
  2. Round Slab Boxes shall be approved for use with luminaires up to 50 lbs and ceiling fans up to 35 lbs.
  3. Round Slab Boxes shall have threaded brass inserts for the attachment of luminaires or ceiling fans.
  4. Slab Boxes shall have eight (8) integrally molded ENT hub connectors with six locking tabs for ENT raceway connection.

### INSTALLATION

#### 3.1 Installation

- A. ENT raceways, fittings, boxes and accessories shall be installed in accordance with the 2009 Canadian Electrical Code, Part 1 – C22.1-02 (CEC) and the 1995 National Building Code of Canada (NBC).
- B. Where ENT penetrates a fire-rated wall, floor or ceiling assembly, an approved firestop system is CSA certified to CSA Standards C22.2, No. 211.0.

See Codes & Standards for additional installation information.

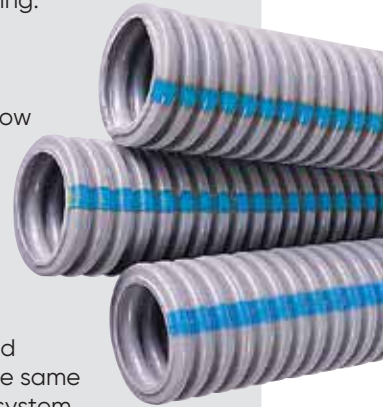

## COR-LINE ENT

Size inches	ID inches	OD inches	Length feet	Product Code
-------------	-----------	-----------	-------------	--------------

### Cor-Line ENT Coils – Blue Stripe



1/2	0.578	0.840	370	012000
3/4	0.778	1.050	240	012008
1	1.000	1.315	160	012018
1-1/4	1.345	1.660	500	012046
1-1/2	1.574	1.900	300	012032
2	2.025	2.375	225	012043

### Cor-Line ENT Reels – Blue Stripe



1/2	0.578	0.840	1500	012004
3/4	0.778	1.050	1000	012009
1	1.000	1.315	750	012019
1-1/4	1.345	1.660	1000	012047
1-1/2	1.574	1.900	750	012033
2	2.025	2.375	500	012044
2-1/2	2.469	2.866	325	012049

Size inches	Length feet	Product Code	Crate Size
-------------	-------------	--------------	------------

### COR-LINE ENT 10' Sticks – Blue Stripe



1/2	10	012005	3600
3/4	10	012006	2200
1	10	012007	1800

#### Storage of Kwikon ENT Tubing

Manufacturer recommends that ENT tubing should not be stored outdoors where subjected to direct sunlight without protective covering, i.e. packaging or tarps.

## KWIKON FITTINGS

Size inches	Part Number	Product Code
-------------	-------------	--------------

### Kwikon Couplings



1/2	KC10	089000
3/4	KC15	089001
1	KC20	089002
1-1/4	KC25	189670
1-1/2	KC30	189671
2	KC35	189672
2-1/2	KC40	089075

### Kwikon Snap-in Connectors



1/2	KTS10	089146
3/4	KTS15	089147
1	KTS20	089148

### Kwikon Connectors\*



1/2	KTA10	089006
3/4	KTA15	089007
1	KTA20	089008
1-1/4	KTA25	189680
1-1/2	KTA30	189681
2	KTA35	189682
2-1/2	KTA40	089076

\*KTA connectors are supplied with locknuts.

### Kwikon Transition Couplings



1/2	KTC10	089012
3/4	KTC15	089013
1	KTC20	089014

## KWIKON FITTINGS

**KWIKON ENT FORM STUBBIES** create conduit stub-downs in concrete without needing to drill holes in the plywood form. Available in the original stubby design, the angled version and the Multi-Link, Kwikon form stubbies also protect the ENT from potential damage during the removal of wood forms.

Size inches	Part Number	Product Code
-------------	-------------	--------------

### Kwikon ENT Form Stubbies



1/2	KSTB-10	089330
3/4	KSTB-15	089331
1	KSTB-20	089332
1-1/4	KSTB-25	089333

The **KWIKON ENT ANGLED FORM STUBBY** gives you the advantage of positioning the ENT at a lower profile within the slab.

Size inches	Part Number	Product Code
-------------	-------------	--------------

### Kwikon ENT Angled Form Stubbies



1/2	KASTB-10	089233
3/4	KASTB-15	089234
1	KASTB-20	089235
1-1/4	KASTB-25	089236
1-1/2	KASTB-30	089238
2	KASTB-35	089239
2-1/2	KASTB-40	089240

The **KWIKON ENT MULTI-LINK FORM STUBBY** features a snap-together design which enables them to be configured in a variety of tightly grouped formations. It also features a thin removable film over the drop opening.

Size inches	Part Number	Product Code
-------------	-------------	--------------

### Kwikon ENT Multi-Link Form Stubbies



1/2	MSTB-10	089031
3/4	MSTB-15	
1	MSTB-20	089025

**KWIKON STUB DOWN FITTINGS** are designed for direct connection to ENT on the horizontal. The flanged base offers a NPSC threaded hub connection on the vertical (at the exit point of the slab) allowing for the direct transition to other raceway products or to ENT connection.

Either way, our Kwikon ENT connection creates a stub down of ENT without penetrating the form.

Designed to offer the optimal balance of bend radius and overall height in the slab, these fittings provide a bend radius of 2-1/2" while standing less than 3-3/8" tall.

Size inches	Part Number	Product Code
-------------	-------------	--------------

### Kwikon (KT90) Stub Down Fittings (Kwikon x Threaded)



1/2	KT90-10	089060
3/4	KT90-15	089059
1	KT90-20	089058

### Kwikon (KK90) Stub Down Fittings (Kwikon x Kwikon)



1/2	KK90-10	089055
3/4	KK90-15	089056
1	KK90-20	089057

The **NEW ENT SUPPORT UNIT (ESU)** raises the tubing or conduit up off the concrete form during the concrete pour maintaining a level raceway and allows for maximum aggregate flow and concrete consolidation.

Easy to use, the ESU snaps around any size of ENT. It is perfect for use in high rise buildings constructed with post-tensioned (PT) concrete slabs.

### FEATURES

- One size fits all 1/2" - 2"
- Securable to the concrete form
- Saves time and labour
- Easy locking mechanism
- Minimal footprint reduces amount of surface contact

Part Number	Product Code
-------------	--------------

### ENT Support Unit (ESU)

ESU-10-35	089149
-----------	--------



## KWIKON SLAB BOXES

### STANDARD SLAB BOXES

- Approved for support of ceiling fans up to 35 lbs. and luminaires up to 50 lbs.
- Concrete-tight.
- Corner and traditional mounting tabs offer contractors two options when installing to the slab deck
- Angled design guides the nail into position within the trim cover area
- All molded connectors have 360° locking tabs that exceed UL and CSA requirements for pull-out.
- Manufactured from high-impact PVC.
- Nonmetallic/non-conducting/non-corroding.
- Threaded brass inserts. (10/32 for ceiling fans, 8/32 for luminaires).
- Supplied as a fully assembled one piece unit.

Size inches	Part Number	Product Code
-------------	-------------	--------------

### Kwikon Slab Boxes w/ Molded Connectors – Volume 44 cu in.



8 x 1/2	SMB-H-10	089455
8 x 3/4	SMB-H-15	089459
4 x 1/2, 4 x 3/4	SMB-H-10/15	089457
4 x 1/2, 2 x 3/4, 2 x 1	SMB-H-10/20	089456
4 x 3/4, 4 x 1	SMB-H-15/20	089463

### Kwikon Slab Boxes w/ Knockouts (w/o Molded Connectors) – Volume 44 cu in.



8 x 1/2	SMB-10	089450
4 x 1/2, 2 x 3/4, 2 x 1	SMB-10/20	089451

### SQUARE SLAB BOXES

- Direct mounting of 4" devices and 4" square covers.
- Mounting feet are located on corners for quicker positioning and securing to form.
- Standard dimension 2-gang cover plates cover all exposed surfaces.

Size inches	Part Number	Product Code
-------------	-------------	--------------

### Kwikon Square Slab Boxes w/ Molded Connectors – Volume 44 cu in.



8 x 1/2	SSBH-10	089452
8 x 3/4	SSBH-15	089453
4 x 1/2, 4 x 3/4	SSBH-10/15	089454
4 x 3/4, 4 x 1	SSBH-15/20	089471

### SHALLOW SLAB BOXES

- Threaded brass inserts (10/32 for ceiling fans, 8/32 for luminaires).
- Approval for support of ceiling fans up to 35 lbs and luminaires up to 50 lbs.
- Overall height of box (2-7/8") allows for use in thinner slabs.
- Clear Vue vacuum formed removable covers

Size inches	Part Number	Product Code
-------------	-------------	--------------

### Kwikon Shallow Slab Boxes w/ Molded Connectors – Volume 36 cu in.



8 x 1/2	SMBS-H-10	089485
8 x 3/4	SMBS-H-15	089487
4 x 1/2, 4 x 3/4	SMBS-H-10/15	089486
4 x 1/2, 2 x 3/4, 2 x 1	SMBS-H-10/20	089488
4 x 3/4, 4 x 1	SMBS-H-15/20	089489

### CONCRETE WALL BOXES

- Fully assembled and installation ready
- Perfectly suited for deep or shallow construction preferences
- Kwikon hubs do not protrude inside the box
- Clear Vue vacuum formed removable covers

Size inches	Part Number	Product Code
-------------	-------------	--------------

### Kwikon Concrete 3-1/2" Deep Concrete Wall Boxes – Volume 38 cu in.



4 x 1/2, 4 x 3/4	SVDB-H-10/15	089496
4 x 3/4, 4 x 1	SVDB-H-15/20	089049
4 x 1/2, 2 x 3/4, 2 x 1	SVDB-H-10/20	089052
8 x 3/4	SVDB-H-15	089065

### Kwikon 2" Shallow Concrete Wall Boxes – Volume 15 cu in.



4 x 1/2	SVSB-H-10	089054
4 x 3/4	SVSB-H-15	089053

### Kwikon Slab Box Extension Ring



SMBR 089494

Adjusts height of SMB/SMBH series slab boxes by 1"

- Easily installed.
- Quickly adjusts to new height.

## ACCESSORIES

Description	Part Number	Product Code
-------------	-------------	--------------

### Tapered Plugs



1/2	TP10	089003
3/4	TP15	089004
1	TP20	089005

Description	Part Number	Product Code
-------------	-------------	--------------

### Cutting Tool



Cutting Tool 1/2" – 1"	CLC20	988210
Cutting Tool 1/2" – 2"	CLC35	988915
Replacement Blade for CLC20	SSB	988211
Replacement Blade for CLC35	SB35	988916



## Slab Box Installation Made Easy

Designed to withstand tough jobsite environments, Kwikon® ENT slab boxes are nonmetallic, nonconductive and noncorroding. All Deep Round Series slab boxes feature our new CORNER MOUNTING TABS. These uniquely positioned corner tabs allow contractors to easily nail Kwikon slab boxes to the slab deck. The angled design guides the nail to be positioned inside the fixture's trim cover, reducing the threat of visible rust bleeding through the finished ceiling.

- Approved for support of ceiling fans up to 35 lbs and luminaries up to 50 lbs
- Corner and traditional mounting tabs offer contractors two options when installing to the slab deck
- Angled design guides the nail into position within the trim cover area
- Ready to install – no assembly required
- Clear Vue vacuum formed removable covers

# The SceptaCon™ Solution

The SceptaCon™ Joint  
Featuring slide-in  
spline locking system

## ...an essential part of your SMART lighting solution

SceptaCon™ is one of the first PVC systems designed for the rigors of trenchless applications. Made of durable Schedule 40 PVC, SceptaCon links seamlessly to existing PVC conduit infrastructure and allows utilities to standardize on PVC throughout their entire electrical system.



*Sceptacon is the ideal solution to short drilling projects where heavy local traffic can't be interrupted.*

Now available in a 2" diameter, SceptaCon is ideally suited for street lighting and traffic signal applications where installation requires a smaller diameter pipe than your typical electrical raceway. As the only approved, boreable PVC electrical raceway available in a 2" size, SceptaCon allows contractors to install RW cables instead of the more expensive TECK cables.

### No Fusion or Cementing Required

With SceptaCon's slide-in locking system, a watertight joint can be made in seconds, without fusion or cementing

### Pressure Rating & Flexibility

SceptaCon is pressure rated to 80 psi and approved for a 65 ft bend radius

### Easier to Handle & No Reel to Return

Installed one length at a time, SceptaCon doesn't require the use of a reel...no reel deposit, no reel truck, and no need to return the reel after use

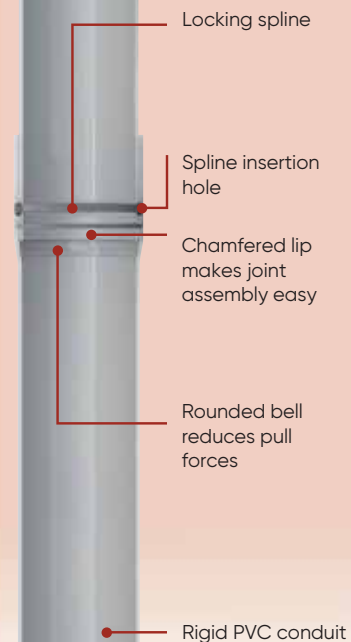

Until now, there have been few choices for electrical conduit in trenchless applications. Non-PVC conduit systems require transition couplings or adapters to connect to existing PVC conduit infrastructure and often a proper transition method does not exist. While existing PVC products are compatible they require set up time and can lack the joint pull-strength needed for directional drilling applications.

SceptaCon™ is one of the first PVC systems designed for the rigors of trenchless applications. It links seamlessly to existing PVC conduit infrastructure and allows utilities to standardize on PVC throughout their entire electrical system.

# PVC Raceway for HDD



SceptaCon PVC Raceway for Horizontal  
Directional Drilling

# SCEPTACON PVC FOR HDD

2" - 6" (53mm - 150mm)



SceptaCon™ is one of the first PVC systems designed for the rigors of trenchless applications. It links seamlessly to existing PVC conduit infrastructure and allows utilities to standardize on PVC throughout their entire electrical system.

And because SceptaCon is made to the same high standards as our Scepter Rigid PVC Conduit, contractors and electrical utilities can be assured of the same level of quality – above ground and below. SceptaCon delivers the performance, reliability and long life you expect from IPEX.

## ADVANTAGES

- 1** No Cementing or Lubrication Required  
SceptaCon's slide-in locking system and pre-installed, pre-lubricated gaskets allow contractors to create a water-tight seal by hand in seconds – in all temperatures without having to worry about solvents or chemicals freezing or drying too quickly.
- 2** No Fusion Required  
Because SceptaCon joints can be quickly joined by hand in seconds, crews don't need large, expensive fusion equipment or special training to create water-tight joints.  
In addition, SceptaCon can be assembled one pipe length at a time, then pulled underground, eliminating the need for long strings of pipe on the job. In this way, SceptaCon is ideal for short haul applications in cramped urban areas.
- 3** Superior Performance  
SceptaCon is made from durable schedule 40 PVC that's resistant to creasing, scoring or flattening when pulled past obstructions in the borehole, yet flexible enough to bend with underground twists and turns. SceptaCon remains round, unlike HDPE which can stretch and become oval. And with PVC's proven 70-year history in underground piping, it's no surprise telecommunication contractors are turning to SceptaCon PVC raceway for reliable performance – now and over the long term.
- 4** Easier to Handle  
SceptaCon saves crews all the hassles of working with HDPE. As any crew knows, cumbersome HDPE reels are heavy and awkward to transport and work with, and the material is notoriously rigid in cold temperatures. On the other hand, SceptaCon is available in convenient 10' and 20' lengths that are lightweight, easy to handle and no problem to work with in all types of weather.

## APPLICATIONS

- Environmentally Sensitive Areas
- Historical Landmarks
- Road and Highway Crossings
- Urban Areas
- Street Lights
- Traffic Lights

## STANDARDS



### FAST AND EASY JOINT ASSEMBLY

SceptaCon needs no special equipment or training joining quickly to create a water-tight seal in seconds.



#### Step 1

Remove the red protective plugs and locking spline. Slide the spigot and bell ends past the pre-lubricated gasket to the positive stop alignment ring.



#### Step 2

Using the insertion hole, completely push the locking spline into the pipe's inner groove to lock lengths together.



#### Step 3

You're done! Our spline locking system ensures they'll stay together during pull-through and over their life underground.



## THE SCEPTACON™ JOINT

Featuring slide-in spline locking system.

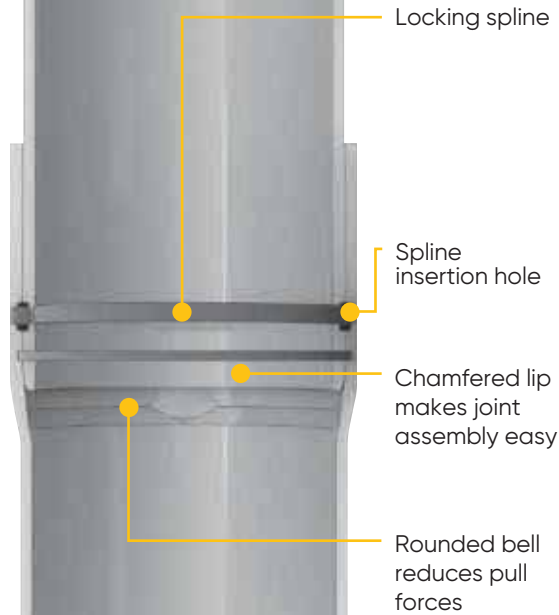

Rigid PVC conduit

## SHORT FORM SPECIFICATIONS

### GENERAL

Installation of conduit in defined areas (such as environmentally sensitive areas, existing roadways and high traffic pedestrian areas) shall be accomplished using trenchless horizontal directional drilling methods.

### PRODUCT

The trenchless raceway system shall be manufactured of schedule 40 PVC and to PVC conduit specifications providing for a seamless transition to rigid nonmetallic conduit, duct or other approved conduit systems. Each length of conduit shall be supplied with end caps, a locking spline, a factory installed pre-lubricated o-ring seal and a positive stop alignment ring. Each length shall incorporate dimensionally precise machined grooves (internal on the bell and external on the spigot) whereby the connection of the raceway lengths creates a cavity for the locking spline. The bell end of each length shall have a label affixed by the manufacturer that provides installation instructions while clearly identifying and protecting the spline insertion opening.

Acceptable manufacturers are: SceptaCon Trenchless Raceway by IPEX.

### APPROVALS

The Trenchless Raceway System shall be third party certified to UL651 and CSA C22.2 No.211.2.

### PERFORMANCE SPECIFICATIONS

SceptaCon is made for fast installation, creating a water-tight seal in seconds with no special fusion equipment or training needed. SceptaCon is manufactured to UL651 and CSA C22.2 no. 211.2 standards and meets all testing requirements of Rigid PVC Conduit (PVC).

- SceptaCon's rated bend radius is sixty five (65) feet
- Rated Pulling Force
 

2" – 3,000 lbs	4" – 8,700 lbs	
3" – 7,000 lbs	5" – 11,300 lbs	6" – 14,000 lbs
- SceptaCon's water tightness using the joint immersion test
  - 80psi pressure without a bending force applied
  - 80psi pressure when subjected to a 65 foot bend radius

### SCEPTACON PRODUCT SELECTION CHART

Nominal Diameter		Product Code	O.D.		I.D.		Min. Wall	
in	mm		in	mm	in	mm	in	mm
2	53	(20') 106421	2.375	60.3	2.067	52.5	0.154	3.9
3	78	(10') 106430 (20') 106431	3.500	88.9	3.068	77.9	0.216	5.5
4	103	(10') 106440 (20') 106441	4.500	114.3	4.026	102.3	0.237	6.0
5	129	(10') 106450 (20') 106451	5.563	141.3	5.047	128.2	0.258	6.6
6	155	(10') 106460 (20') 106461	6.625	168.3	6.065	154.1	0.280	7.1

Every length is delivered with protective plugs to keep the conduit free of dirt and debris during shipping and job site handling.

# new Sceptalight LED

Introducing the NEW Sceptalight LED light fixture and adapter kit. Sceptalight LEDs offer significant energy savings and can last beyond 50,000 hours without a single need for maintenance. Certified and tested for use in indoor, outdoor, wet locations, wash down and corrosive environments, Sceptalight LEDs are certified to the latest LED light fixture standards and NEMA 4X approved.



## RETROFIT OPTION

Sceptalight LEDs can easily retrofit onto existing installations for increased energy savings.

## CORROSION RESISTANT

Heat sink is coated with a durable e-coat layer that prevents corrosion.

## NEMA 4X AND IP66 RATED

Approved for wet locations, wash down and corrosive environments.

## HEAT DISSIPATION

Specially designed heat sink ensures long life and optimum performance for over 50,000 hours.

## ENERGY EFFICIENT

1,000 lumens of light output is produced with only 15 Watts of electricity.

## DIMMABLE

Lights are dimmable down to 5% for maximum control of the lighting environment.

## POLYCARBONATE GLOBE

Impact and weather resistant for tough environments.

Whether you're looking for economical outdoor lighting solutions or corrosion-resistant fixtures for punishing industrial environments, Sceptalight fixtures from IPEX prove themselves to be all-round performers in a variety of indoor and outdoor applications. Sceptalight fixtures are made from a glass-reinforced thermoplastic polyester resin, which enable them to stand up better to corrosive elements than metal. This thermoplastic design marries an unrivaled balance of strength, stiffness and toughness with all the benefits users appreciate of Scepter rigid PVC conduit and fittings – long life, easy servicing and high impact-resistance.

Sceptalight's thermoplastic construction offers outstanding corrosion and chemical resistance. And its interior and exterior silicone gaskets create a watertight seal, the reason it performs equally well indoors and outside.

Wherever you need a lighting fixture that can withstand exposure to chemicals, fluids or harsh physical conditions, you'll find a home for Sceptalight.

# Nonmetallic Light Fixtures



Sceptalight Nonmetallic Light Fixtures

# SCEPTALIGHT NONMETALLIC LIGHT FIXTURES



Whether you're looking for economical outdoor lighting solutions, corrosion-resistant fixtures for punishing industrial environments or energy-saving LED, Sceptalight fixtures from IPEX prove themselves to be all-round performers in a variety of indoor and outdoor applications. Sceptalight fixtures are made from a glass-reinforced thermoplastic polyester resin, which enable them to stand up better to corrosive elements than metal. This thermoplastic design marries an unrivaled balance of strength, stiffness and toughness with all the benefits users appreciate of Scepter Rigid PVC Conduit and Fittings – long life, easy servicing and high impact-resistance.

Sceptalight's thermoplastic construction offers outstanding corrosion and chemical resistance. Silicone gaskets in Sceptalight fixtures – mounted at the base of the globe and within the ceiling box – provide a water- and vapour-tight seal which protects the electrical connections inside.

Wherever you need a lighting fixture that can withstand exposure to chemicals, fluids or harsh physical conditions, you'll find a home for Sceptalight.

## APPLICATIONS

- Chemical Plant
- Food Processing
- Highway Tunnel
- Mine Tunnels
- Walk-in Freezers
- Industrial/Commercial
- Marine
- Agricultural
- Waste Water
- Greenhouses

## STANDARDS



### WET LOCATIONS

C22.2 No. 250  
CSA Listed to UL 1598  
Minimum 60°C supply conductors

CSA certified for wet locations, Sceptalight fixtures are built to withstand any environment where liquids drip, splash or flow against electrical equipment. And our polycarbonate globes are an excellent alternative to glass in punishing environments where high impact resistance is important. Sceptalight fixtures can operate in extreme temperatures and are resistant to damaging ultraviolet rays. For years, our fixtures have been proven performers on docks, wharfs, decks, walkways, shipyards and a variety of other applications where exposed to the elements.

#### LIGHT OPTIONS

LED	✓
Incandescent	✓
Compact Fluorescent	✓



### HAZARDOUS LOCATIONS

CSA Listed to UL 844  
CLASS I, DIV 2 Groups A, B, C & D  
CLASS II, DIV 2 Groups F & G  
Minimum 90°C supply conductors

Sceptalight offers fixtures that are CSA certified for hazardous locations, making them the ideal choice for specific harsh industrial environments involving flammable or explosive gases, vapours or dusts. In addition to their sturdy construction, all our fixtures rated for hazardous locations include a heat-treated globe designed to endure drastic temperature changes such as direct spray of cool water on a hot fixture. Sceptalight fixtures are equipped with brass screws and inserts to ensure performance in punishing industrial conditions.

#### LIGHT OPTIONS

LED	✓
Incandescent	✓
Compact Fluorescent	✓



## ADVANTAGES

- ① Available in LED, compact fluorescent and incandescent to suit a variety of applications.
- ② Stable Construction  
Reinforced support feet offer secure mounting.
- ③ Adaptable  
Threaded conduit hubs permit connection to nonmetallic and metallic raceways.
- ④ Watertight Seal  
Temperature and weather-resistant silicone gaskets protect fixture from moisture penetration.
- ⑤ Long Life  
Sceptalight nonmetallic fixtures provide long life and easy servicing—unlike metal fixtures and guards that can corrode and seize together.
- ⑥ Indoor/Outdoor Use  
UV-resistant material makes Sceptalight fixtures suitable for both indoor and outdoor use.
- ⑦ Corrosion Resistant  
Thermoplastic construction resists attack from acids, alcohols, alkalis, organic solvents, detergents/ cleaners, greases and oils as well as many other types of chemicals.  
Withstands exposure to direct sunlight, heat, salt water and extreme weather.
- ⑧ Durable, Impact Resistant  
High-impact nonmetallic guard resists physical impact, chemical attack and heat-induced deformation.

## SHORT FORM SPECIFICATIONS

Light fixtures shall be nonmetallic and constructed of 30% glass filled polyester material exhibiting a maximum linear expansion of  $1.4 \times 10^{-5}$  in./in./°F. Fixtures shall be assembled with high temperature silicone gaskets, brass inserts and screws.

Incandescent light fixtures shall be rated for use with a Maximum 150 Watt incandescent lamp. Compact fluorescent light fixtures shall be of the wattage specified and be supplied complete with lamp and ballast (high power factor, low harmonic electronic for 18 & 26 Watt fixtures and magnetic for 7, 9 & 13 Watt fixtures).

Light fixtures shall be third-party certified to CSA C22.2 No. 9 and C22.2 No. 250 for indoor/outdoor wet location use and where the specified installation requires; Class I Div 2 and Class II Div 2 hazardous location use.

LED light fixtures shall be third-party certified to CSA 22.2 250.0. LED light fixtures will also be NEMA 4X and IP66 rated for wash-down and corrosive environments. LED light fixtures for hazardous use locations shall be third-party certified to UL 844 for Class I Div 2 and Class II Div 2 hazardous location use.

LED Retrofit Light Engines shall be certified to CSA T.I.L. B-79A and conform to UL 1598C.

Approved products: Sceptalight LVPE/LVPF/LVPL/LBPE/LPMF/LPPL series light fixtures manufactured by IPEX Electrical Inc.

# SCEPTALIGHT LED

Introducing three new Sceptalight LED products: the LED Retrofit Light Engine, the Heavy-Duty LED Light Fixture and the Utility LED Light Fixture. Sceptalight LEDs offer significant energy savings, up to 85% compared to incandescent, and up to 34% compared to fluorescents. Moreover, Sceptalight LEDs can last beyond 50,000 hours without a single need for maintenance.

Constructed of very strong and durable materials, the polycarbonate globe is impact resistant and is resistant to UV light degradation. The specially designed aluminum heat sink dissipates the heat generated by the LEDs to the exterior environment ensuring long-life and optimal performance in both hot and cold environments. Sceptalight LEDs have been tested and certified for use in indoor, outdoor, wet location, wash down, corrosive and hazardous\* environments. They are certified to the latest LED light fixture standards and NEMA 4X approved.

\* LVPF-LED-HAZ only



## PHOTOMETRIC DATA

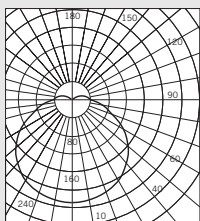

15W 120V  
Frosted LED

## STANDARDS

PRODUCT	APPROVED USE	STANDARDS
LLED-15 (light engine only)	WET LOCATION	CSA T.I.L. B-79A, UL 1598C
LVPE-LED	WET LOCATION	CSA C22.2 250, UL 1598C, UL 844
LVPF-LED-HAZ	HAZARDOUS LOCATION Class I, Div 2 Groups A, B, C & D and Class II, Div 2 Groups F & G	CSA C22.2 250, UL 1598C

**NEW**  
CSA Approved for Hazardous Use



### RETROFIT OPTION

Sceptalight LEDs can easily retrofit onto existing installations for increased energy savings.

### CORROSION RESISTANT

Heat sink is coated with a durable e-coat layer that prevents corrosion.

### NEMA 4X AND IP66 RATED

Approved for wet locations, wash down and corrosive environments.

### HEAT DISSIPATION

Specially designed heat sink ensures long life and optimum performance for over 50,000 hours.

### ENERGY EFFICIENT

1,000 lumens of light output is produced with only 15 Watts of electricity.

### DIMMABLE

Lights are dimmable down to 5% for maximum control of the lighting environment.

### POLYCARBONATE GLOBE

Impact and weather resistant for tough environments.

## TECHNICAL SPECIFICATIONS

LUMEN OUTPUT ..... 1000 LM  
INPUT VOLTAGE..... 120 VAC  
FREQUENCY..... 60 HZ  
NOMINAL POWER ..... 15 W  
COLOUR TEMPERATURE..... 5000 K  
CRI..... > 80

POWER FACTOR ..... 0.98  
TOTAL HARMONIC DISTORTION.....10.5%  
OPERATING TEMPERATURE ..... -40°C TO 40°C  
DIMMABILITY RANGE.....DOWN TO 5%  
RATED LIFE ..... > 50,000 HOURS  
WARRANTY\* ..... 5 YEARS

\*LIMITED WARRANTY & LIMITATION OF LIABILITY: Consult IPEX Sceptalight™ LED Retrofit Light Engine Specific Terms and Conditions of Sale and Limited Warranty and Limitation of Liability for further details, available at [www.ipexna.com](http://www.ipexna.com)

# SCEPTALIGHT COMPACT FLUORESCENT

Sceptalight Compact Fluorescent fixtures combine the outstanding corrosion and chemical resistance of their thermoplastic design with the energy-saving advantages of compact fluorescents. Working four to five times more efficiently per watt than incandescents, Sceptalight compact fluorescents provide 10-20 times the lamp life. Without sacrificing light levels, they use 75% less energy than incandescents for a lower total energy and maintenance cost. They are available in twin tube and quad tube configurations and include ballast.

## Twin Tubes

- Available in 7, 9 & 13 Watt
- Standard Magnetic Ballast

## Quad Tubes

- Available in 18 & 26 Watt
- Electronic Ballast provides "Instant Start" at temps as low as -25°C
- Offers 10,000 hours of lamp life



## PHOTOMETRIC DATA

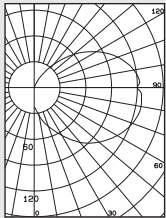

26W Quad  
Compact  
Flourescent

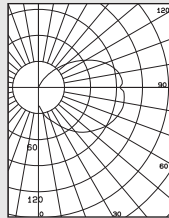

18W Quad  
Compact  
Flourescent

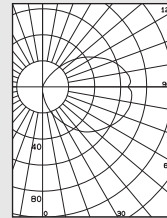

13W Twin-  
Tube Compact  
Flourescent





### STABLE CONSTRUCTION

Reinforced support feet offer secure mounting.

### ADAPTABLE

Threaded conduit hubs permit connection to nonmetallic and metallic raceways.

### WATERTIGHT SEAL

Temperature and weather-resistant gaskets protect fixture from moisture penetration.

### LONG LIFE

Sceptalight nonmetallic fixtures provide long life and easy servicing—unlike metal fixtures and guards that can corrode and seize together.

### INDOOR/OUTDOOR USE

UV-resistant material makes Sceptalight fixtures suitable for both indoor and outdoor use.

### CORROSION RESISTANT

Thermoplastic construction resists attack from acids, alcohols, alkalis, organic solvents, detergents/cleaners, greases and oils as well as many other types of chemicals. Withstands exposure to direct sunlight, heat, and extreme weather.

### DURABLE, IMPACT RESISTANCE

High-impact nonmetallic guard resists physical impact, chemical attack and heat-induced deformation.

# SCEPTALIGHT INCANDESCENT

Sceptalight incandescent fixtures make the most practical choice to meet the daily needs of commercial, industrial, marine and agricultural applications. Our incandescents will take up to a 150 watt incandescent bulb and are ideal for short burn times as well as flashing and dimming applications.

For light to medium duty applications that do not require the same level of ruggedness, Sceptalight has a low-cost ceiling-mounted Utility Light Fixture available in standard, clear polycarbonate and coloured heat-resistant globes.



## PHOTOMETRIC DATA

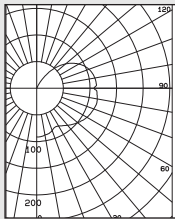

100W 120V  
Coated A19  
Incandescent

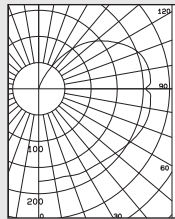

150W 120V  
Coated A21  
Incandescent



### INSTALLATION FLEXIBILITY

Fixtures can be mounted in ceiling, wall or pendant methods to accommodate installation requirements.

### INDOOR/OUTDOOR USE

Temperature and weather-resistant gaskets protect fixture from moisture penetration.

### COST EFFECTIVE SOLUTION

Inexpensive to install, the fixture takes up to a 150 watt incandescent bulb.

### ADAPTABLE LIGHTING ENVIRONMENTS

Ideal for short burn times, flashing & dimming applications.

### COLOURED GLOBES

Available in a range of coloured heat-resistant globes to transform the light into an indicator or warning light.

### CORROSION RESISTANT

Thermoplastic construction withstands exposure to direct sunlight, heat & extreme weather.

## MOUNTING OPTIONS

Sceptalight LED can be retrofit with Ceiling Mounts only.

### CEILING MOUNT

Box with four 3/4" threaded hubs and integral mounting feet.

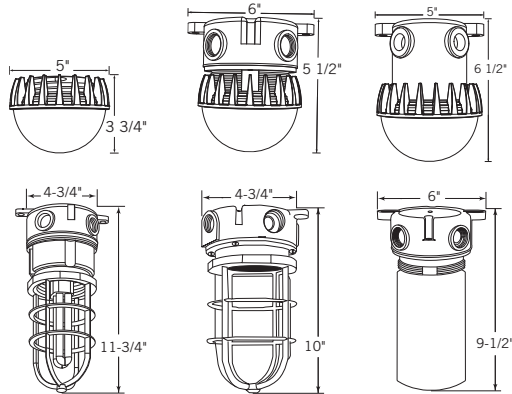

### PENDANT MOUNT

Pendant cap with 3/4" threaded hub and a locking set screw.

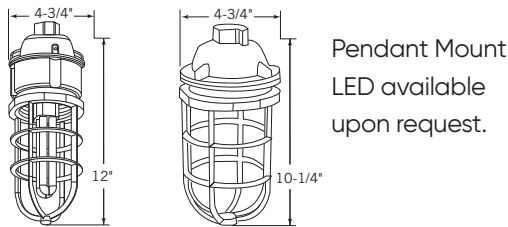

### WALL MOUNT

Box with four 3/4" threaded hubs, 90° wall bracket and integral mounting feet.

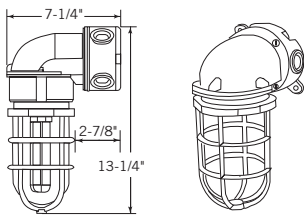

### CEILING MOUNT UTILITY FIXTURES

Box with four 3/4" threaded hubs and integral mounting feet.

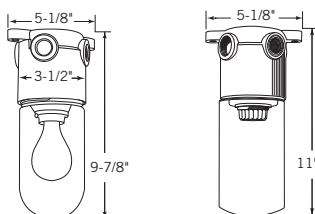

## GLOBE OPTIONS

(For incandescent and fluorescent options only)

### Standard Clear Glass Globes

Ideal for general purpose area lighting for either indoor or outdoor use.

### Clear Polycarbonate Globes

Impact resistant globes for added protection in case of accidental contact .

### Coloured Heat-Resistant Glass Globes

Available in red, blue, green or amber – to transform the light to an indicator or warning light.



Clear Polycarbonate



Standard/Heat-treated Clear Glass



Heat-treated Red Glass



Heat-treated Blue Glass



Heat-treated Green Glass



Heat-treated Amber Glass

## WET LOCATION USE



Description	Part Number	Product Code	Standard Packaging
-------------	-------------	--------------	--------------------

### Sceptalight LED

15 W LED Retrofit Light Engine	LLED-15	277018	20
15 W LED LVPF Heavy Duty Light Fixture	LVPF-LED-HAZ	277074	6
15 W LED LVPE Utility Light Fixture	LVPE-LED	277075	6

### Ceiling mount with standard clear glass globe

150 W Incandescent	LVPF150C	077225	6
150 W Incandescent (Less Guard)	LVPF150LG	077237	6
7 W Compact Fluorescent	LVPL7C	077120	6
9 W Compact Fluorescent	LVPL9C	077121	6
13 W Compact Fluorescent	LVPL13C	077122	6
18 W Compact Fluorescent	LVPL18C	077210	6
26 W Compact Fluorescent	LVPL26C	077170	6

### Ceiling mount with clear polycarbonate globe (no guard)

7 W Compact Fluorescent	LVPL7PCC	077145	6
9 W Compact Fluorescent	LVPL9PCC	077155	6
13 W Compact Fluorescent	LVPL13PCC	077165	6
18 W Compact Fluorescent	LVPL18PCC	077211	6
26 W Compact Fluorescent	LVPL26PCC	077176	6

### Pendant mount with standard clear glass globe

150 W Incandescent	LPMF150C	077231	6
13 W Compact Fluorescent	LPPL13C	077185	6
18 W Compact Fluorescent	LPPL18C	077212	6
26 W Compact Fluorescent	LPPL26C	077184	6

### Pendant mount with clear polycarbonate globe (no guard)

7 W Compact Fluorescent	LPPL7PCC	077345	6
9 W Compact Fluorescent	LPPL9PCC	077355	6
13 W Compact Fluorescent	LPPL13PCC	077365	6
18 W Compact Fluorescent	LPPL18PCC	077273	6
26 W Compact Fluorescent	LPPL26PCC	077375	6

### Wall Mount

90° Wall Mount Bracket	LWB150	077233	1
------------------------	--------	--------	---

Note: For wall mount fixtures select the desired ceiling mount fixture from above and add LWB150 90° wall mount bracket.

## WET LOCATION USE CONT'D

Description	Part Number	Product Code	Standard Packaging
-------------	-------------	--------------	--------------------

### Utility Light - 150 Watt Incandescent (Ceiling Mount Only)

w/ Std. Glass Globe	LVPE150-10/15	077493	6
w/ Polycarbonate Globe	LVPE150-PCC*	077181	6
w/ Std. Glass Globe & Clamp-on Guard	LVPE150-1015G	077402	6
w/ H.R. Glass Globe Clear	LVPE150HRC	077578	6
w/ H.R. Glass Globe Red	LVPE150HRR	077599	6
w/ H.R. Glass Globe Blue	LVPE150HRB	077579	6
w/ H.R. Glass Globe Green	LVPE150HRG	077597	6
w/ H.R. Glass Globe Amber	LVPE150HRA	077598	6
Clamp-on Guard for LVPE	LVPU150	077558	30

\* Maximum 60W incandescent lamp Type A

## HAZARDOUS LOCATION USE



Description	Part Number	Product Code	Standard Packaging
-------------	-------------	--------------	--------------------

### Ceiling mount with frosted polycarbonate globe

15 W LED LVPF Heavy Duty Light Fixture	LVPF-LED-HAZ	277074	6
--	--------------	--------	---

### Ceiling mount with heat resistant glass globe

150 W Incandescent Clear	LVPF150HRC-HAZ	077414	6
150 W Incandescent Red	LVPF150HRR-HAZ	077415	6
150 W Incandescent Blue	LVPF150HRB-HAZ	077416	6
150 W Incandescent Green	LVPF150HRG-HAZ	077417	6
150 W Incandescent Amber	LVPF150HRG-HAZ	077494	6
18 W Compact Fluorescent Clear	LVPL18HRC-HAZ	077347	6
18 W Compact Fluorescent Red	LVPL18HRR-HAZ	077348	6
18 W Compact Fluorescent Blue	LVPL18HRB-HAZ	077349	6
18 W Compact Fluorescent Green	LVPL18HRG-HAZ	077353	6
18 W Compact Fluorescent Amber	LVPL18HRA-HAZ	077354	6
26 W Compact Fluorescent Clear	LVPL26HRC-HAZ	077377	6
26 W Compact Fluorescent Red	LVPL26HRR-HAZ	077378	6
26 W Compact Fluorescent Blue	LVPL26HRB-HAZ	077379	6
26 W Compact Fluorescent Green	LVPL26HRG-HAZ	077399	6
26 W Compact Fluorescent Amber	LVPL26HRA-HAZ	077400	6

### Pendant mount with heat resistant glass globe

150 W Incandescent Clear	LPMF150HRC-HAZ	077495	6
150 W Incandescent Red	LPMF150HRR-HAZ	077496	6
18 W Compact Fluorescent Clear	LPPL18HRC-HAZ	077500	6
18 W Compact Fluorescent Red	LPPL18HRR-HAZ	077498	6
26 W Compact Fluorescent Clear	LPPL26HRC-HAZ	077407	6
26 W Compact Fluorescent Red	LPPL26HRR-HAZ	077409	6

## HAZARDOUS LOCATION USE CONT'D



Description	Part Number	Product Code	Standard Packaging
-------------	-------------	--------------	--------------------

### Wall Mount

90° Wall Mount Bracket	LWB150	077233	1
------------------------	--------	--------	---

Note: For wall mount fixtures select the desired ceiling mount fixture from above and add LWB150 90° wall mount bracket.

Sceptalight compact fluorescent light fixtures are supplied complete with lamp and ballast.

All hazardous location fixtures are rated CLASS I, DIV 2 Groups A, B, C & D and CLASS II DIV 2 Groups F & G.

## ACCESSORIES & COMPONENTS

Description	Part Number	Product Code	Standard Packaging
-------------	-------------	--------------	--------------------

### Standard Glass Globes

Clear	LGC150	077247	1
-------	--------	--------	---



### Heat Resistant Globes

Clear	LG150T	077909	1
Red	LCGR150T	077239	1
Blue	LCGB150T	077910	1
Green	LCGG150T	077241	1
Amber	LCGA150T	077242	1



### Polycarbonate Globes (for use with compact fluorescent or maximum 60W incandescent lamp)

Clear	LPCC18	077911	1
Red	LPCR18	077912	1
Blue	LPCB18	077913	1
Green	LPCG18	077914	1
Amber	LPCA18	077915	1

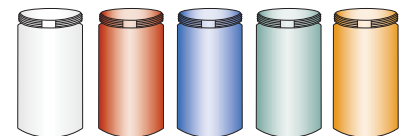

### Threaded Junction Boxes

	LFB150C	077250	6
	LFB150T *	077251	6

\*LFB150T complete with 1/2 threaded" hole in center of cover



## ACCESSORIES & COMPONENTS CONT'D

Description	Part Number	Product Code	Standard Packaging
-------------	-------------	--------------	--------------------

### Fixture Components (LVPF, LVPL, LPMF, LPPL)

Ceiling Mount Box	LVPB 150	077243	1
Pendant Mount Cap	LPC 150	077246	1
90 Wall Bracket	LWB 150	077233	1
Socket Base Assembly	LSBA 150	077245	1
Medium Base Replacement Socket	LSOC 150	077249	1
Screw-on Guard	LVPG 150	077978	1

### Replacement Lamps

7 Watt	LD/E 7	072841	1
9 Watt	LD/E 9	072844	1
13 Watt	LD/E 13	072847	1
18 Watt (Quad)	LD/E 18	077947	1
26 Watt (Quad)	LD/E 26	077081	1

### Replacement Lamp Holders

7/9 Watt Lamp Holder	LLH 7/9	072843	1
13 Watt Lamp Holder	LLH 13	072849	1
18 Watt Lamp Holder (4 Pin)	LLH 18	072818	1
26 Watt Lamp Holder (4 Pin)	LLH 26	077082	1

### Ballasts

7/9 Watt Magnetic Ballast (NPF)	LEB 7/9	072842	1
13 Watt Magnetic Ballast (NPF)	LEB 13	072848	1
18 Watt Electronic Ballast (HPF)	LEB 18	077224	1
26 Watt Electronic Ballast (HPF)	LEB 26	077080	1

### Gaskets

Box Gasket	LBGASK 150	072820	1
Lamp Gasket	LLGASK 150	076971	1



The premier ducting product on the market, IPEX Super Duct® is specifically engineered and quality manufactured to deliver the high-impact and crush strength demanded by today's utility companies, for underground ducting applications.

Made from a specially formulated compound, Super Duct can withstand high physical loads, while providing the natural flexibility for field bending to accommodate minor changes in elevation or direction. And Super Duct's smooth bore makes cable pulling easier.

# Power & Communications Duct



Super Duct Pipe

68

Super Duct Fittings

71

Underground Duct Spacers

74



# SUPER DUCT POWER & COMMUNICATIONS DUCT

2" - 6" (50mm - 150mm)

## SUPER<sup>®</sup> DUCT

Super Duct is recognized by major utilities, contractors and engineering firms as the premier ducting product available on the market.

Super Duct is manufactured with a specialized compound, and engineered for high impact and crush strength specifically required by utilities for underground duct. This compound also enhances the friction coefficient of Super Duct.

Super Duct (Type DB-2) is certified to CSA Standard C22.2 No. 211.1 both for encasement in concrete/masonry and for direct burial.

### APPLICATIONS

- Utilities
- Telecom
- Hospitals / Medical Complexes
- Commercial Buildings
- Communications
- Cable

### STANDARDS

 CSA C22.2 No. 211.1

### ADVANTAGES

- 1 Light Weight**  
Super Duct is easy to carry and install, reducing labour requirements and costs.
- 2 Long Lengths**  
Super Duct is available in 10' (3m) and 20' (6.1m) lengths, minimizing the number of connections needed.
- 3 Bell Ends**  
Super Duct is bell-ended, allowing for easy assembly in the field.
- 4 High Compressive Strength**  
Super Duct's specially formulated compound is designed to withstand high loads.
- 5 Low Coefficient of Friction**  
The smooth bore of Super Duct facilitates cable pulling and eliminates costly cable damage.
- 6 Quality Control**  
Stringent, continuous testing ensures that Super Duct is a consistently high quality product.
- 7 Field Bending**  
The natural flexibility of IPEX Super Duct allows field bending, to accommodate minor changes in elevation or direction.



## SUPER DUCT (TYPE DB-2)

Description	CSA Requirements	Reference
Pipe Stiffness @ 5%	43.5 psi (300 kPa)	CSA C22.2 No. 211.1
Crush Resistance	198 lbs. @ 73°F (90 kg @ 23°C) 10% max. residual deflection	CSA C22.2 No. 211.1
Impact Resistance	45 ft. lbf @ 73°F (61J @ 23°C) 25 ft. lbf @ 0°F (34J @ -18°C)	CSA C22.2 No. 211.1
Residual Stress	149°F (65°C) for 4 hours. Allow to cool to 73°F (23°C). 0.5% shrinkage allowed.	CSA C22.2 No. 211.1
Joint Tightness	5 psi (35 kPa) internal water pressure applied for 24 hours.	CSA C22.2 No. 211.1

Note: Super Duct meets or exceeds all CSA requirements.

### FIELD BENDING

Field bending can accommodate minor changes in elevation or direction without the use of special sweeps or fittings. The following table indicates typical maximum offset bends that can be achieved by cold bending.

### ALLOWABLE OFFSET FOR SUPER DUCT

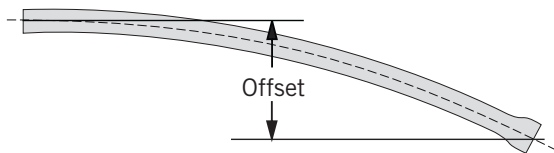

Size		Max Allowable Offset 10' Length		Max Allowable Offset 20' Length	
in.	mm	in.	mm	in.	mm
2	50	20	508	79	2 007
3	75	14	356	56	1 422
3-1/2	90	12	305	49	1 245
4	100	11	279	43	1 092
5	125	7	178	35	889
6	150	7	178	29	737

#### NOTES:

- Axial deflection should not be attempted at the joints.
- The above values were established for ambient temperatures above the freezing point. Increased radii may be desirable at below-freezing temperatures.

## SHORT FORM SPECIFICATIONS

### PRODUCT

Duct shall be IPEX Super Duct or approved equal. Duct, fittings, Monobloc spacers and solvent cement shall be provided by the same manufacturer to assure system integrity.

The duct is to be secured mechanically with IPEX Monobloc or vertical lock spacers to prevent disturbance to the alignment during installation.

### IDENTIFICATION

Duct shall be identified for type and manufacturer and shall be traceable to plant location, date, shift and machine of manufacture. The markings shall be legible and permanent.

### MATERIAL

Duct for use in underground, encased or direct burial applications shall be made from PVC compound that includes inert modifiers to give high modulus of elasticity, improved weatherability and deflection characteristics.

### STANDARDS

Type DB-2 Super Duct and Solvent Cement Fittings as manufactured by IPEX Inc. shall be used for direct burial and/or concrete encased applications. The duct and fittings must be certified to CSA Standard C22.2 No. 211.1 and be installed in accordance with the Canadian Electrical Code Part 1, Rule 12-1150 through 12-1166. Polyethylene push-fit couplings are only to be used in concrete-encased application.



## INSTALLATION

### BENDS

Standard 90°, 45° and 22 1/2° bends are available from sizes 2" through to 6" in 24", 36", 42" and 60" radius. All bends are supplied with 6" (15.2cm) tangents. The centre line lay length (L) can be calculated using;

$$L = \left( \pi r \times \frac{\S}{180} \right) + 2 (\text{tangent})$$

Where:  $\pi$  = 3.14  
 L = centre line lay length  
 r = radius of bend  
 $\S$  = angle of bend  
 tangent = 6"

Example: for a 3" 90° bend with a 36" radius - calculate the lay length:

$$L = \left( 3.14 \times 36 \times \frac{90^\circ}{180} \right) + 2 (6)$$

$$L = 69 \text{ inches}$$

$$L(\text{metres}) = \frac{L \text{ imperial}}{12 \times 3.281} = \frac{69"}{39.37} = 1.75\text{m}$$

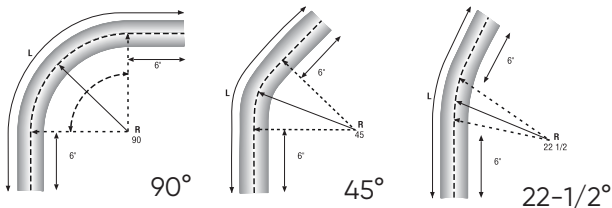

## EXPANSION AND CONTRACTION

The following precautions should be exercised when extreme temperature variations are anticipated during the installation of IPEX Super Duct.

1. Allow extra duct footage at each tie-in for contraction when duct temperature is higher than soil temperature. Allow extra room for expansion if reverse condition exists.
2. Backfill from tie-in point toward end of duct run.

The coefficient of thermal expansion of IPEX Super Duct is  $3 \times 10^{-5}$  in./in./°F ( $5.4 \times 10^{-5}$  mm/mm/°C). These charts show the expansion that can be expected at various temperature ranges for unburied (unrestrained) duct.

PVC Pipe Length Variation due to Temperature Change (°F)  
 Coefficient =  $3.6 \times 10^{-4}$  in./ft./°F

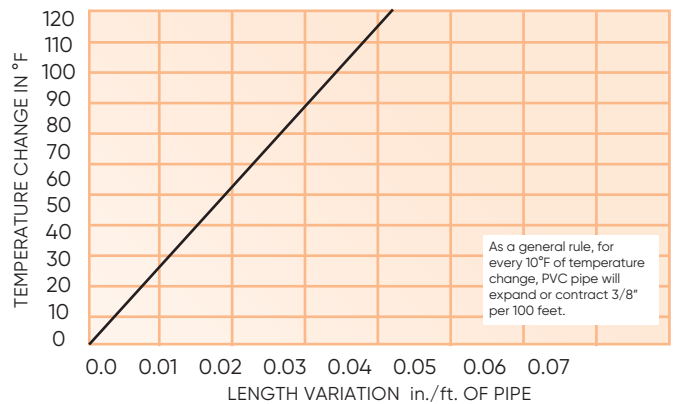

PVC Pipe Length Variation due to Temperature Change (°C)  
 Coefficient =  $.054 \times 10^{-5}$  mm/m/°C

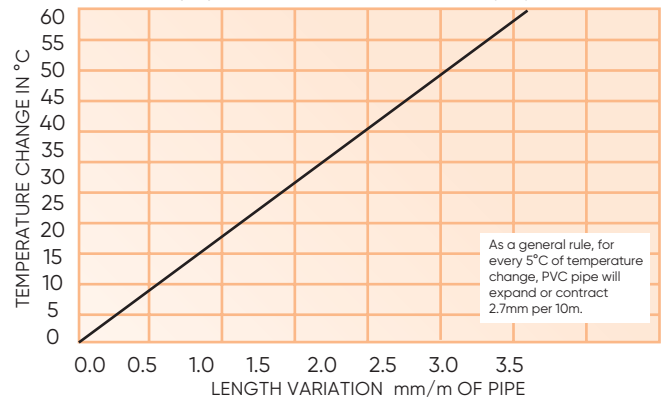

### STATIC FRICTION COEFFICIENT

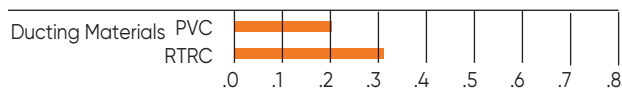

### SUPER DUCT DIMENSIONS

Dimension		Minimum ID		Nominal Wall		Average OD	
in	mm	in	mm	in	mm	in	mm
2	50	2.001	50.83	.082	2.08	2.250	57.15
3	75	3.000	76.20	.097	2.46	3.250	82.55
3-1/2	90	3.480	88.39	.109	2.77	3.730	94.74
4	100	3.941	100.10	.120	3.05	4.216	107.09
5	125	4.974	126.34	.153	3.89	5.299	134.60
6	150	5.896	149.76	.180	4.57	6.275	159.39

## SUPER DUCT PRODUCT SELECTION

Dimension (in)	Product Code	Product Code B.C.	Ft/Crate	Weight/100' (lbs)
----------------	--------------	-------------------	----------	-------------------

### CSA Type II – 10' Length Belled



2	008220	*008225	2,460	33.7
3	008230	*008233	1,120	61.2
3-1/2	008235	*008235	810	77.3
4	008240	*008244	630	99.2
5	008250	*008253	430	159.6
6	008260	*008263	280	226.6

\*Product Codes are for B.C. only.

### CSA Type II – 20' Length Belled

2	008221	*008226	4,920	33.7
3	008231	*008234	2,240	61.2
3-1/2	008236	*008236	1,620	77.3
4	008241	*008245	1,260	99.2
5	008251	*008254	860	159.6
6	008261	*008264	560	226.6

\*Product Codes are for B.C. only.

Dimension (in)	Product Code	Ft/Crate	Weight/100' (lbs)
----------------	--------------	----------	-------------------

### CSA Type II – Split Duct

2	008222	2,460	33.7
3	008232	1,120	61.2
3-1/2	008237	810	77.3
4	008242	630	99.2
5	008252	430	159.6
6	008262	280	226.6

## SUPER DUCT FITTINGS

Size inches	Part Number	Product Code
-------------	-------------	--------------

### PVC Coupling – Solvent Weld



2	SWC020	029001
2 (long)	SWC020L	029009
3	SWC030	029002
3-1/2	SWC035	029003
4	SWC040	029004
5	SWC050	029005
6	SWC060	029006

### Polyethylene Coupling – Push Fit\*



2	PFC020	029011
3	PFC030	029012
3-1/2	PFC035	029013
4	PFC040	029014
5	PFC050	029015
6	PFC060	029016

\* Suitable for concrete-encased applications only

### PVC 5° Coupling – Solvent Weld



2	5ACS20	029041
3	5ACS30	029042
3-1/2	5ACS35	029043
4	5ACS40	029044
5	5ACS50	029045
6	5ACS60	029046

### Polyethylene 5° Coupling – Push Fit\*



2	5APF20	029620
3	5APF30	029030
3-1/2	5APF35	029502
4	5APF40	029998
5	5APF50	029050

\* Suitable for concrete-encased applications only

### Expansion Joint



2	EXPJ20	029151
3	EXPJ30	029152
3-1/2	EXPJ35	029153
4	EXPJ40	029154

## SUPER DUCT FITTINGS

Size inches	Part Number	Product Code
-------------	-------------	--------------

### Reducer Coupling – Solvent Weld



3 x 2	RC3020	029021
3-1/2 x 2	RC3520	029039
3-1/2 x 3	RC3530	029022
4 x 2	RC4020	029023
4 x 3	RC4030	029024
4 x 3-1/2	RC4035	029025
5 x 4	RC5040	029026
6 x 4	RC6040	029027

### Split Wye – Solvent Weld



2	SPLY20	029051
3	SPLY30	029052
3-1/2	SPLY35	029053
4	SPLY40	029054

### PVC Bell Ends



2	BELL20	029061
3	BELL30	029062
3-1/2	BELL35	029063
4	BELL40	029064
5	BELL50	029065
6	BELL60	029066

### Terminator with Knock-Out Plugs



3	TERM30	029826
3 1/2	TERM35	029523
4 (with holes)	TERM40H	029822
4 (no holes)	TERM40W	029827

### Cap – Solvent Weld



2	SWCA20	029071
3	SWCA30	029072
3-1/2	SWCA35	029073
4	SWCA40	029074
5	SWCA50	029075
6	SWCA60	029076

### Tapered Plug



2	PLUG20	029131
3	PLUG30	029132
3-1/2	PLUG35	029133
4	PLUG40	029078
5	PLUG50	029079
6	PLUG60	029136

Size inches	Part Number	Product Code	Product Code Prairies
-------------	-------------	--------------	-----------------------

### 90° Long Sweep Bend



2 x 24 R	902024	029091	*129091
2 x 36 R	902036	029092	*129092
2 x 60 R	902060	029036	*129036
3 x 24 R	903024	029055	*129055
3 x 36 R	903036	029093	*129093
3 x 60 R	903060	029134	*129134
3-1/2 x 24 R	903524	029123	*129123
3-1/2 x 36 R	903536	029094	*129094
3-1/2 x 60 R	903560	029135	*129135
4 x 24 R	904024	029047	*129047
4 x 36 R	904036	029095	*129095
4 x 60 R	904060	029096	*129096
5 x 42 R	905042	029097	*129097
5 x 60 R	905060	029037	*129037
6 x 60 R	906060	029098	*129098

\*Product Codes are for the Prairie Provinces only.

### 45° Long Sweep Bend



2 x 24 R	452024	029111	*129111
2 x 36 R	452036	029112	*129112
3 x 24 R	453024	029082	*129082
3 x 36 R	453036	029113	*129113
3-1/2 x 36 R	453536	029114	*129114
4 x 24 R	454024	029128	*129128
4 x 36 R	454036	029115	*129115
4 x 60 R	454060	029116	*129116
5 x 42 R	455042	029117	*129117
6 x 60 R	456060	029118	*129118

\*Product Codes are for the Prairie Provinces only.

### 22 1/2° Long Sweep Bend





3 x 36 R	223036	029085	*129085
4 x 36 R	224036	029204	*129204
5 x 42 R	225042	029249	*129249

\*Product Codes are for the Prairie Provinces only.

Note: Special radius bends are available upon request.

## DIMENSIONS - FITTINGS

	Size inches	Part Number	Product Code
	2 & 2-1/2	UPP35	029386
	3 & 3-1/2	UPP45	029387
	4	UPP55	029388
	5	UPP60	029389
	6	UPP65	029390

	Size inches	Part Number	Product Code
	2	FEMA20	029141
	3	FEMA30	029142
	3-1/2	FEMA35	029143
	4	FEMA40	029144
	5	FEMA50	029145
	6	FEMA60	029146

	Size inches	Part Number	Product Code
	3 x 2	ARIG3020	029191
	4 x 2	ARIG4020	029192
	4 x 3	ARIG4030	029187

	Size inches	Part Number	Product Code
	3-1/2	ACFB35	029163
	4	ACFB40	029164

	Size inches	Part Number	Product Code
	2	ARIG20	029181
	2 (long)	ARIG20L	029188
	3	ARIG30	029182
	3-1/2	ARIG35	029183
	4	ARIG40	029184
	5	ARIG50	029185
	6	ARIG60	029186

Note: Duct to RTRC Conduit Adapters are available on request.



**Scepter®**  
Rigid PVC Conduit & Fittings

- High tensile & impact strength
- Concrete-tight
- FT-4 rated



**EPR**

- Fast and easy installation
- Restores structural integrity
- Repair made while leaving cables inside



**Sceptralight®**

- Wet or hazardous locations
- Water-tight seal protects from moisture & corrosion
- Impact resistant – ideal for indoor & outdoor use



## Make the right choice!

Why is genuine Scepter the premier choice of electrical contractors?

- Performance
- Quality Products
- Committed Sales Special
- Innovation

Depend on IPEX for quality products and superior service.

# UNDERGROUND DUCT SPACERS

2" - 6" (50mm - 150mm)

IPEX offers a wide range of conduit and duct spacers for concrete encased duct bank assemblies. Our spacers offer consistent operation, stability and relieve direct stress for duct materials.

## INTERLOCKING SPACERS

IPEX's interlocking spacers provide uniform separation between the rows and columns of conduits and when assembled with conduit create a stable structure for the concrete. Spacers connect quickly and easily by sliding together horizontally and snapping together vertically and provide true customization for any configuration of duct bank. Superior features like the molded rebar slots for efficient drop-in installation of full length rebar and integral holes in base spacers for securing in place save time and effort.

Spacers are available in sizes to independently support 2", 3", 4", 5" and 6" conduit and each size is offered a range of separation from 1" to 3".

## MONOBLOC™ SPACERS

Monobloc spacers accommodate the specific dimensions of DB and EB duct and can be used as both a base spacer and an intermediate spacer for versatility. Monobloc spacers support DB/EB duct in sizes 2" - 5" and are available in a range of configurations that provide 1" to 3" separation between ducts. To minimize jobsite assembly these spacers are available as single, double, triple or quad run units (way). Any number of parallel conduit runs can be accommodated by combining Monobloc spacers (i.e. a 2-way and a 3-way create a 5-way).

Monobloc spacers are resilient at all temperatures, lightweight and easy to use. Readily available in 29 configurations, many with a molded-in rebar holder, these spacers are an economical choice for virtually any duct bank installation.

## APPLICATIONS

- Underground duct banks
- Medical campus
- University campus

## ADVANTAGES

- 1** Moulded Re-bar innovation  
These provide better alignment and more uniform distribution of re-bar in a duct bank, making duct bank installation even faster and easier.
- 2** Innovative design  
Twenty-six of the 29 different Monobloc spacers can be used interchangeably as either a base or intermediate unit.
- 3** Maximum flexibility  
Different sized Monobloc spacers can be easily grouped to create the required width of duct bank.
- 4** Tough and resilient  
Made of resilient, high-density polyethylene, our spacers easily withstand inclement weather and severe conditions normally found on a construction site.
- 5** Integral holes offer base spacer fastening and stabilization.



## DID YOU KNOW?

You can lower both material and labour costs with the 4x3x3 Monobloc base spacer. By reducing concrete requirements one inch in duct bank encasements, this base spacer can save four cubic yards of concrete in a 500-foot long, 30-inch wide duct bank.



## INTERLOCKING SPACERS

IPEX's interlocking spacers provide uniform separation between the rows and columns of conduits and when assembled with conduit create a stable structure for the concrete. Spacers connect quickly and easily by sliding together horizontally and snapping together vertically and provide true customization for any configuration of duct bank. Superior features like the molded rebar slots for efficient drop-in installation of full length rebar and integral holes in base spacers for securing in place save time and effort.

RECOMMENDED DISTANCE: 6' - 7'

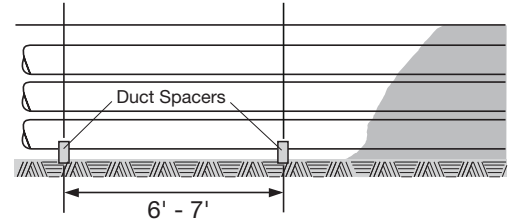

Size (inches)	Part Number	Product Code	Dimensions (inches)					
			C	D	E	F	G	H

### Intermediate Vertical-Lok Spacers

2 x 1-1/2	IS3530	029550	1.52	1.50	3.95	3.95	3.94	0.63
2 x 2	IS3535	029551	2.03	2.06	4.48	4.48	4.47	0.63
2 x 3	IS3545	029552	3.00	3.03	5.45	5.45	5.44	0.63
3 x 1-1/2	IS4530	029582	1.50	1.45	5.15	5.12	5.12	0.88
3 x 2	IS4535	029554	2.00	1.88	5.64	5.63	5.63	0.88
3 x 3	IS4545	029555	3.00	2.88	6.66	6.63	6.63	0.88
4 x 1	IS5520	029583	1.00	1.03	5.66	5.63	5.63	0.88
4 x 1-1/2	IS5530	029557	1.50	1.39	6.13	6.14	6.13	0.88
4 x 2	IS5535	029558	2.00	1.88	6.64	6.63	6.63	0.88
4 x 3	IS5545	029559	3.00	2.90	7.64	7.64	7.63	0.88
5 x 1-1/2	IS6030	029584	1.68	1.69	7.37	7.37	7.37	0.88
5 x 2	IS6035	029561	2.25	2.15	7.89	7.89	7.88	0.88
5 x 3	IS6045	029562	3.06	2.96	8.70	8.70	8.69	0.88
6 x 1-1/2	IS6530	029563	1.50	1.38	8.24	8.22	8.21	0.88
6 x 2	IS6535	029564	2.00	1.89	8.74	8.73	8.72	0.88
6 x 3	IS6545	029565	3.00	2.90	9.77	9.77	9.75	0.88
8 x 2	IS8035	029294	2.06	2.00	10.58	10.80	10.80	*

\* Do not have rebar slots or base holes

Size (inches)	Part Number	Product Code	Dimensions (inches)		
			A	B	H

### Base Vertical-Lok Spacers

2 x 1-1/2	BS3530	029566	3.04	4.25	0.63
2 x 2	BS3535	029567	3.04	4.25	0.63
2 x 3	BS3545	029568	3.04	4.25	0.63
3 x 1-1/2	BS4530	029585	3.00	5.84	0.88
3 x 2	BS4535	029570	2.97	4.78	0.88
3 x 3	BS4545	029571	3.00	4.81	0.88
4 x 1	BS5520	029586	3.00	5.32	0.88
4 x 1-1/2	BS5530	029573	3.00	5.31	0.88
4 x 2	BS5535	029574	3.06	5.38	0.88
4 x 3	BS5545	029575	3.06	5.38	0.88
5 x 1-1/2	BS6030	029587	3.00	5.84	0.88
5 x 2	BS6035	029577	3.13	5.94	0.88
5 x 3	BS6045	029578	3.19	6.00	0.88
6 x 1-1/2	BS6530	029579	3.02	6.38	0.88
6 x 2	BS6535	029580	3.02	6.38	0.88
6 x 3	BS6545	029581	3.00	6.38	0.88
8 x 2	BS8035	029293	3.00	7.25	*

\* Do not have rebar slots or base holes

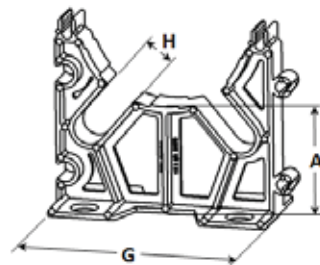
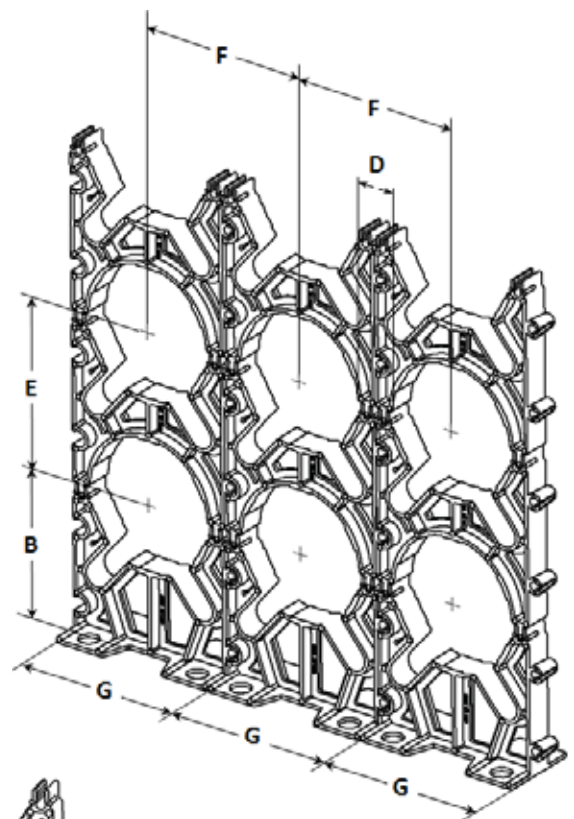
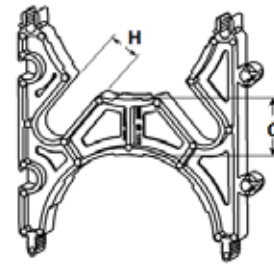

# MONOBLOC DUCT SPACERS

## TECHNICAL INFORMATION

Normal Pipe Size Inches A	Vertical Spacing Inches B	Horizontal Spacing Inches C	Ground Clearance Inches D	Number of Ways E
2	1-1/2	1-1/2	3	2
3	1-1/2	1-1/2	3	2
3-1/2	1	1	2	2-3-4
4	1	1	2	1-2-3-4
4	1-1/2	1-1/2	3	2-3-4
4	2	2	3	1-2-3-4
4	3	3	3	2-3-4
4	3	3	4	2-3-4
4-1/2	2	2	3	1-2-3
5	1-1/2	2-1/8	3-5/8	1
5	1-1/2	1-1/2	3	2-3-4

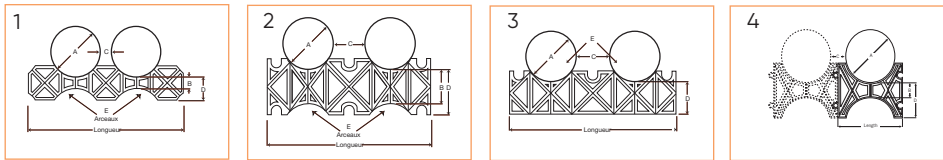

Description	Product Code	Dimensional Drawing	Length inches	Quantity Per Bundle	Quantity Per Pallet
2 x 1-1/2 x 1-1/2 x 3	2 way 029473	2	7.9	25	1200
3 x 1-1/2 x 1-1/2 x 3	2 way 029474	2	10.3	25	900
3-1/2 x 1 x 1 x 2	2 way 029860	2	12.4	25	1100
3-1/2 x 1 x 1 x 2	3 way 029861	2	17.3	25	800
3-1/2 x 1 x 1 x 2	4 way 029479	2	20.9	25	600
4 x 1 x 1 x 2	1 way 029475	2	8.3	25	1600
4 x 1 x 1 x 2	2 way 029476	2	13.5	25	1000
4 x 1 x 1 x 2	3 way 029477	2	18.8	25	800
4 x 1 x 1 x 2	4 way 029478	2	24.2	25	600
4 x 1-1/2 x 1-1/2 x 3	2 way 029470	1	14.2	25	600
4 x 1-1/2 x 1-1/2 x 3	3 way 029471	1	20.0	25	500
4 x 1-1/2 x 1-1/2 x 3	4 way 029472	1	26.0	25	400
4 x 2 x 2 x 3	1 way 029480	2	8.3	25	900
4 x 2 x 2 x 3	2 way 029464	1	14.5	25	600
4 x 2 x 2 x 3	3 way 029465	1	20.7	25	400
4 x 2 x 2 x 3	4 way 029499	1	27.0	25	400
4 x 3 x 3 x 3 (Base)	2 way 029466	3	15.0	25	600
4 x 3 x 3 x 3 (Base)	3 way 029488	3	22.5	25	400
4 x 3 x 3 x 3 (Base)	4 way 029489	3	30.0	25	300
4 x 3 x 3 x 4	2 way 029469	1	15.0	25	500
4 x 3 x 3 x 4	3 way 029497	1	22.5	25	400
4 x 3 x 3 x 4	4 way 029498	1	30.1	25	200
4-1/2 x 2 x 2 x 3	1 way 029485	2	8.7	25	800
4-1/2 x 2 x 2 x 3	2 way 029486	2	15.5	25	500
4-1/2 x 2 x 2 x 3	3 way 029487	2	22.2	25	400
* 5 x 1-1/2 x 2-1/8 x 3-5/8	1 way 029455	4	7.0	50 (CTN)	500
5 x 1-1/2 x 1-1/2 x 3	2 way 029494	2	16.2	25	500
5 x 1-1/2 x 1-1/2 x 3	3 way 029495	2	23.1	25	400
5 x 1-1/2 x 1-1/2 x 3	4 way 029496	2	30.0	25	300

\* Horizontal Locked Spacer

Items marked in bold indicate a change/addition from the previous price list.

In the past, there have been few choices for electrical box solutions for ICF construction, but INEXO's electrical box designed specifically for ICF provides the easy installation and finished look that installers and building owners appreciate.

INEXO's patented design allows the boxes to be easily installed anywhere on an ICF wall following concrete pour. With no special training or tools required, the INEXO electrical box is easily inserted into the ICF wall and the box's "teeth" are pushed into place with an audible click to ensure the box is secure.

Available in single, double and triple gang designs for both residential and commercial applications, the INEXO electrical box offers plenty of capacity for the latest applications.

# Specialty Products



INEXO ICF Boxes

78



Guy Guards

82

# INEXO ICF BOXES

1/2", 3/4", 1" (12mm, 19mm, 25mm)

## INEXO™

Until now there have been few choices when attempting to provide a truly professional electrical box solution for Insulated Concrete Form homes. Traditional electrical boxes are tedious to install and often require a fair amount of ingenuity and additional labour to provide a less than ideal finished product. Other boxes offered to ICF builders require installation before the concrete pour, throwing off your project time-line.

INEXO's patented<sup>1</sup> design provides a truly professional solution that works with your production schedule and provides the quality installation and finished look that builders require and owners appreciate. INEXO boxes link seamlessly with existing ICF materials, tools and methods. A complete offering designed for ICF walls allow builders to standardize on the use of electrical boxes throughout the building.

<sup>1</sup> Patent No. 6,932,628 & Patent Pending

### APPLICATIONS

- Insulated Concrete Form Buildings
- Schools
- Churches
- Hotels

### STANDARDS



### ADVANTAGES

- 1 Installation after concrete pour allows you to follow traditional production schedules
- 2 Positioning – Boxes can be installed anywhere on the ICF wall allowing for more variety in box positioning as installers are no longer required to affix to the ICF ties or drill and secure to the concrete wall.
- 3 Availability – Residential boxes are available in single, double and triple gang options.
- 4 Certification – Boxes are fully CSA certified to UL standards for use in ICF and can resist pull forces exceeding 100 lbs – (twice the standard requirement).

### FAST AND EASY INSTALLATION

Installing INEXO boxes requires no special training making the transition to a new solution seamless.

#### STEP 1:

Select the position for your box. Using a hot-knife or cutting tool, cut the opening in the EPS foam.



#### STEP 2:

Insert the INEXO box into your opening and push the 'teeth' into place until you hear the 'click' – so you know your box is secure. If you are positioned next to a tie, you can utilize two of the 'teeth' on the non-tie side and use the flange holes on the opposite side to screw into the plastic tie.



#### STEP 3:

Pull through your NMD cable and continue.



Single gang box provides 19 cubic inch capacity

INEXO provides a 1/2" drywall setback resulting in a professional finish.

With an insertion depth of 2-1/4" and a smooth back, the INEXO box is designed specifically for ICF.



RESIDENTIAL BOX DESIGNED FOR NMD CABLE (14/2 - 10/3).

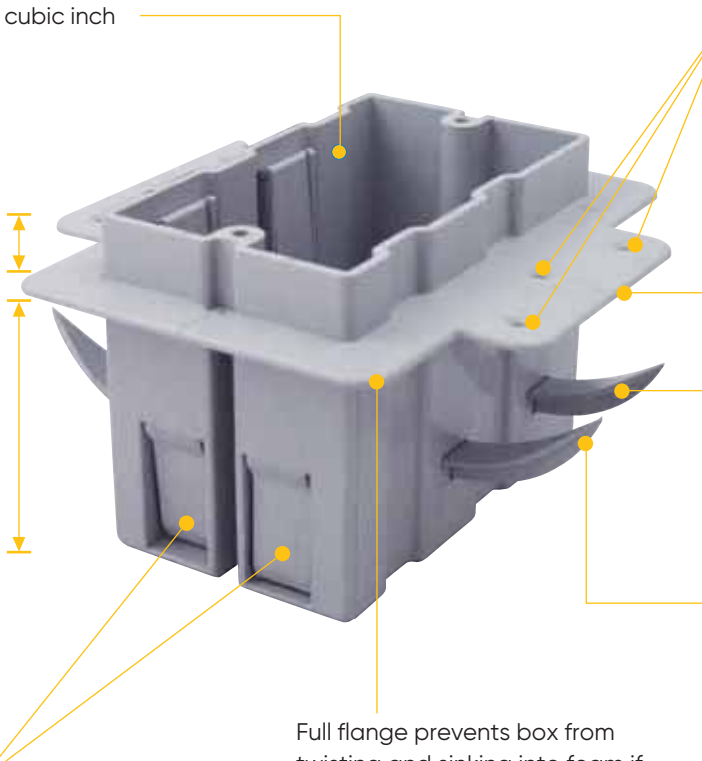

Greater installation versatility with 3 screw hole choices and flanges on both sides.

Laser level guides for the most precise box placement

'TEETH' can be easily removed and replaced and provide an audible 'click' when fully engaged and secured to the EPS foam.

'TEETH' lock in place for a rigid hold that won't loosen.

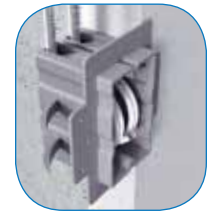

Full flange prevents box from twisting and sinking into foam if over-tightened. This innovation allows installers to provide a professional straight finish with no lop-sided boxes.

COMMERCIAL BOX DESIGNED FOR ARMoured CABLE (AC) OR NMD CABLE.

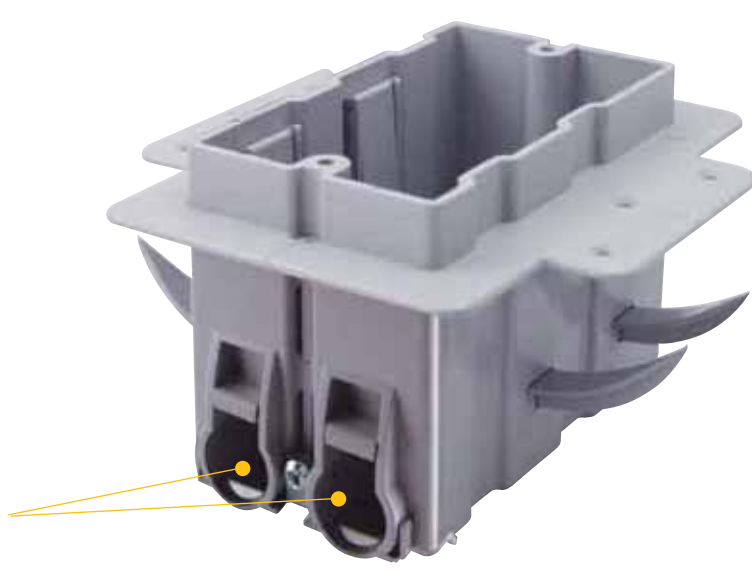

## INEXO BOXES

Description	Part Number	Product Code
-------------	-------------	--------------

### Residential (NMD Cable 14/2 – 10/3)



Single Gang	ICF-1-RLX	220003
Double Gang	ICF-2-RLX	220004
Triple Gang	ICF-3-RLX	220005

### Commercial (AC or NMD Cable)



Single Gang	ICF-1-CU	220006
Double Gang	ICF-2-CU	220007
Triple Gang	ICF-3-CU	220008

Description	Part Number	Product Code
-------------	-------------	--------------

### Low Voltage Divider



Divider	LVD-RLX	220100
For residential box only		



The new INEXO ICF box divider provides contractors with a quick and convenient way to separate different voltage sources in the same box.

RESIDENTIAL BOX  
WITH LOW VOLTAGE DIVIDER

# INEXO<sup>®</sup>

THE ICF BOX

Insertion depth  
of 2-1/4"

'TEETH' can be  
easily removed  
and replaced.

'TEETH' lock in  
place providing  
a rigid hold in  
the EPS foam.

Greater installation  
versatility with 3 screw  
hole choices and  
flanges on both sides.

Full flange  
prevents box  
from twisting  
and sinking into  
foam if over-  
tightened

INEXO provides  
a 1/2" drywall  
setback resulting  
in a professional  
finish

Single gang box  
provides 19 cubic  
inch capacity



Scan to view our  
product demo  
video or visit our  
website

## THE INNOVATIVE ELECTRICAL BOX FOR INSULATED CONCRETE FORM CONSTRUCTION



For complete product information,  
visit [www.ipexna.com/inexo](http://www.ipexna.com/inexo)

# GUY GUARDS

6-1/2' - 7' (2m - 2.13m)

AVAILABLE IN SELECT AREAS ONLY.

IPEX Guy Guards are safety warning devices which signal the presence of guy wires attached to telephone and power distribution poles. These brightly coloured, guards slide over the metal rods or cables reducing the risk of injury.

## APPLICATIONS

- Support and stabilize poles and antennas.

## ADVANTAGES

- 1 Highly Visible Colour**  
 Guy Guards are available in standard bright yellow or bright green to easily alert passers-by to the presence of guy wire. Other colours and/or coloured stripes are also available.
- 2 Flexible Structure**  
 Made of polyethylene polymer, these devices are highly resistant to impact, even in cold weather.
- 3 Long Life**  
 IPEX Guy Guards resist corrosion and oxidation. Their mechanical features are therefore unaffected by exposure to ultraviolet rays and severe weather conditions.
- 4 Easy Installation**  
 The Guy Guard is fastened to the guy wire with a noncorroding, zinc alloy clamp. This clamp is equipped with a double-jaw gripper system which locks the guard in place and enables it to be easily removed and replaced for maintenance purposes.

## SHORT FORM SPECIFICATIONS

Guy Guards shall be manufactured from medium density polyethylene. The name of the manufacturer and date produced shall be hot stamped on the face of the guard for permanent identification. Each guy guard shall be equipped with a two-piece noncorroding, zinc alloy clamp.

## STANDARD DIMENSIONS

Description	Product Code	Length		Inside Diameter (Average)		Overlap		Wall Thickness (Average)		Std Pkg (Bundle)	Crate Quantity	Approximate Weight	
		ft	m	in	mm	in	mm	in	mm			lbs/ft	kg/m
Small Yellow	25504	6.5	2.00	1.75	44.45	2.36	60	0.083	2.1	10	140	0.43	0.64



Mechanically and chemically resistant to a host of environmental conditions, above and below ground, FiberTel™ high density polyethylene (HDPE) innerduct is ideal for both short and long runs, cross-country distances, in communications, data, cable television, power utility and general purpose ducting applications.

FiberTel's unique attributes - flexibility, durability, light weight, high tensile strength and resistance to UV radiation - make it suitable for a variety of installation methods including trenchless technology, directly plowed, placed in open trenches or pulled in casing conduits.

# Telecommunication Systems



FiberTel

84

# FIBERTEL HDPE INNERDUCT

1/2" - 8" (12mm - 200mm)



FiberTel® High Density Polyethylene (HDPE) Innerduct is certified to CSA C22.2 No. 327 HDPE conduit for both SDR11 and SDR13.5 wall thicknesses. FiberTel is available in various colours and sizes and combines the features of flexibility, durability, lightweight and ease of installation.

Mechanically and chemically resistant to a host of environmental conditions, FiberTel is resistant to decomposition, oxidation, and hostile elements that cause damage to other materials. Used for communication, data, cable television, power and general purpose ducting, FiberTel is ideal for both short runs and cross-country distances. Always check for proper use and application with the local authority having jurisdiction before installation.

A special feature of FiberTel is that it can be engineered to suit your needs. The wall thickness, diameter, colour, resin type and coil lengths can all be specified to meet the requirements of your project.

## APPLICATIONS

- Communication
- Data
- Cable Television
- Power and General Purpose Ducting

## STANDARDS

SDR 11 and 13.5 (1/2" - 4")



Electrical CSA C22.2 No. 327

## ADVANTAGES

- 1 Durable**  
FiberTel is constructed of high density polyethylene offering a high tensile strength reducing elongation and stretching. This results in an increased lifespan and lower maintenance costs.
- 2 Weather Resistant**  
FiberTel features a unique formulation that protects it against the harmful effects of excessive ultraviolet rays. For above-ground installations, no special covering, coating or protection is required.
- 3 Colour Coding**  
FiberTel is available in a multitude of colours. It can also be permanently marked with a single or triple stripe identification system. The coloured stripe is actually part of the pipe wall and will always remain visible, permanently identifying the pipe.
- 4 Wall Surface**  
The smooth interior surface of FiberTel offers reduced friction making cables easier to pull.
- 5 Sequential Printing**  
FiberTel coils and reels come complete with sequential footage printing on the pipe indicating how much footage is left after installation. This is a very convenient feature for people in the field!
- 6 User Friendly**  
The flexibility of FiberTel allows for easy bending during installation. Breaking due to expansion and contraction is virtually eliminated. FiberTel can absorb sudden impact without suffering damage – even in extreme conditions.
- 7 Pull Strings and Mule Tapes**  
FiberTel is available with various types of pull strings or mule tapes upon request.
- 8 Quality Control**  
FiberTel is manufactured under strict quality control, ensuring that only top quality product leaves our manufacturing facilities. Our quality process extends from the raw material to the finished goods.

## PRODUCT SELECTION CHART

Nominal Pipe Size		Average OD			DR 11				DR 13.5			
		Nom.	Min.	Max.	Min. Average Wall Thickness and Tolerance		Min. Avg. Inside Dia.	Wgt	Min. Average Wall Thickness and Tolerance		Min. Avg. inside dia.	Wgt
					Wall Thickness	Wall (+) Tolerance			Wall Thickness	Wall (+) Tolerance		
in.	mm	mm	mm	mm	mm	mm	mm	Kg/m	mm	mm	mm	Kg/m
1/2	12	21.34	21.20	21.40	1.94	0.51	16.30	0.13	1.58	0.51	17.02	0.11
3/4	20	26.67	26.60	26.80	2.42	0.51	20.73	0.19	1.98	0.51	21.63	0.16
1	25	33.40	33.30	33.50	3.04	0.51	26.21	0.30	2.47	0.51	27.33	0.25
1-1/4	32	42.16	42.00	42.30	3.83	0.51	33.31	0.46	3.12	0.51	34.73	0.39
1-1/2	40	48.26	48.10	48.40	4.39	0.53	38.27	0.60	3.57	0.51	39.93	0.51
2	50	60.33	60.20	60.50	5.48	0.66	47.91	0.94	4.47	0.54	50.18	0.79
2-1/2	65	73.03	72.80	73.20	6.64	0.80	57.92	1.38	5.41	0.65	60.68	1.15
3	75	101.60	88.70	89.10	8.08	0.97	70.60	2.05	6.59	0.79	73.95	1.70
4	100	114.30	113.80	114.80	10.39	1.25	90.52	3.39	8.47	1.02	94.83	2.82



### DID YOU KNOW?

Polyethylene is a thermoplastic which expands and contracts with temperature changes. If pipe is expected to contract after it is installed, it should be snaked in the trench, or if expansion is anticipated, it should be installed straight.

### Other non-certified FiberTel options are available

- Wall thicknesses (Sch 40/80, SDR9, SDR15.5, SDR17)
- Sizes (5", 6", 8")
- Internal and/or external ribs

Contact your Sales rep to find out more about our certified and non-certified HDPE pipe products.



## INSTALLATION

FiberTel pipe should be cut square using a hand or power saw. All burrs and cuttings must be removed to ensure a good reliable joint.

Joining FiberTel requires no sophisticated tools or special equipment. FiberTel can be heat-fused using standard equipment or joined with compression fittings.

FiberTel can be installed in an open trench, direct plowed, or installed using various trenchless technology methods.

Polyethylene is a thermoplastic which expands and contracts with temperature changes. If pipe is expected to contract after it is installed, it should be snaked in the trench, or if expansion is anticipated, it should be installed straight.

The bottom of the trench and the backfill materials must be free of stones, rocks or debris that may damage the pipe.

# NOTES

A series of horizontal dashed lines providing a template for writing notes.





# Bookmark Our Website

[www.ipexna.com](http://www.ipexna.com)



**PRODUCT INFO,  
TECHNICAL  
DOCUMENTS,  
ON-SITE TRAINING  
& MUCH MORE ...**



**OUR SCEPTER ELECTRICAL CATALOGUE & ELECTRICAL POCKET PRO INCLUDE MORE INFORMATION ON:**

- Conduit & Fittings
- Light Fixtures
- ENT Tubing & Fittings
- Duct
- and much more ...

**available at [www.ipexna.com](http://www.ipexna.com)**

## SALES AND CUSTOMER SERVICE

Customers call IPEX Electrical Inc.

Toll Free: (866) 473-9462

[www.ipexna.com](http://www.ipexna.com)

### About the IPEX Group of Companies

As leading suppliers of thermoplastic piping systems, the IPEX Group of Companies provides our customers with some of the world's largest and most comprehensive product lines. All IPEX products are backed by more than 50 years of experience. With state-of-the-art manufacturing facilities and distribution centers across North America, we have established a reputation for product innovation, quality, end-user focus and performance.

Markets served by IPEX group products are:

- Electrical systems
- Telecommunications and utility piping systems
- PVC, CPVC, PP, PVDF, PE, ABS, and PEX pipe and fittings
- Industrial process piping systems
- Municipal pressure and gravity piping systems
- Plumbing and mechanical piping systems
- Electrofusion systems for gas and water
- Industrial, plumbing and electrical cements
- Irrigation systems

Products are manufactured by IPEX Electrical Inc.

Cor-line®, FiberTel®, JBox™, Kwikon®, SceptaCon™, Sceptalight™ and Super Duct® are trademarks of IPEX Branding Inc.

This literature is published in good faith and is believed to be reliable. However, it does not represent and/or warrant in any manner the information and suggestions contained in this brochure. Data presented is the result of laboratory tests and field experience.

A policy of ongoing product improvement is maintained. This may result in modifications of features and/or specifications without notice.



**IPEX**  
by **alixis**

CTELNAIP190502CR2  
© 2019 IPEX EL0041C