

HMI

PUSH BUTTONS

TIMERS

SENSORS

CONTROLLERS

RELAYS

POWER SUPPLIES

DRIVES

## Locations

### PRINCE EDWARD ISLAND

George Clow  
Branch Manager  
**Charlottetown**  
Harris & Roome Supply  
13 Walker Drive  
Charlottetown, PE C1A 8S5  
Tel: (902) 566-1404  
Fax: (902) 566-4065

### NEW BRUNSWICK

Vern Doucet  
Branch Manager  
**Bathurst**  
Harris & Roome Supply  
P.O. Box 776  
1765 Connolly Avenue  
Bathurst, NB E2A 3Z6  
Tel: (506) 548-2922  
Fax: (506) 546-1517

Peter Horncastle  
Branch Manager  
**Florenceville**  
Harris & Roome Supply  
P.O. Box 432  
16647 Route # 2  
Florenceville, NB E7L 1Y9  
Tel: (506) 392-6084  
Fax: (506) 392-8314

Don Justason  
Branch Manager  
**Fredericton**  
Harris & Roome Supply  
P.O. Box 396, Station "A"  
668 Prospect Street  
Fredericton, NB E3B 4Z9  
Tel: (506) 458-8265  
Fax: (506) 452-9753

Jim Crozier  
Branch Manager  
**Moncton**  
Harris & Roome Supply  
385 Edinburgh Drive  
Moncton, NB E1E 2L2  
Tel: (506) 853-8188  
Fax: (506) 859-8109

Ken Haines  
Branch Manager  
**Saint John**  
Harris & Roome Supply  
P.O. Box 2480  
300 Charlotte Street  
Saint John, NB E2L 3V9  
Tel: (506) 634-2094  
Fax: (506) 634-8018

### NOVA SCOTIA

Cecil Boutilier  
Branch Manager  
**Bridgewater**  
Harris & Roome Supply  
P.O. Box 356  
108 Logan Road  
Bridgewater, NS B4V 2W9  
Tel: (902) 543-9155  
Fax: (902) 543-5137

Fred Haynes  
Branch Manager  
**Dartmouth**  
Harris & Roome Supply  
P.O. Box 935  
260 Brownlow Avenue  
Dartmouth, NS B2Y 3Z6  
Tel: (902) 468-6665  
Fax: (902) 468-2696

Michael MacKinnon  
Manager Automation Controls  
Harris & Roome Supply  
**Automation Controls Division**  
P.O. Box 935  
260 Brownlow Avenue  
Dartmouth, NS B2Y 3Z6  
Tel: (902) 468-2865  
Fax: (902) 481-2740

Dave Wood  
Sales Manager - Comm/Data  
Harris & Roome Supply  
**Comm/Data Division**  
P.O. Box 935  
260 Brownlow Avenue  
Dartmouth, NS B2Y 3Z6  
Tel: (902) 481-2565  
Fax: (902) 481-2951

Dennis Cummings  
Branch 7 Account Manager - Oil & Gas  
Harris & Roome Supply  
**Oil & Gas Division**  
P.O. Box 935  
260 Brownlow Avenue  
Dartmouth, NS B2Y 3Z6  
Tel: (902) 468-6665  
Fax: (902) 481-5547

Fred Haynes  
Branch Manager  
**Halifax**  
Harris & Roome Supply  
P.O. Box 9078, Station "A"  
3600 Joseph Howe Drive  
Halifax, NS B3K 5M7  
Tel: (902) 443-8311  
Fax: (902) 443-5171

Mark Malley  
Branch Manager  
**Kentville**  
Harris & Roome Supply  
9 Roscoe Drive  
Kentville, NS B4N 3V7  
Tel: (902) 678-2800  
Fax: (902) 679-1997

Terry Richardson  
Branch Manager  
**New Glasgow**  
Harris & Roome Supply  
P.O. Box 695  
136 Terra Cotta Drive  
New Glasgow, NS B2H 5G2  
Tel: (902) 755-4673  
Fax: (902) 752-3881

Dave Rose  
Branch Manager  
**Sydney**  
Harris & Roome Supply  
P.O. Box 159  
1100 Upper Prince Street  
Sydney, NS B1P 5P6  
Tel: (902) 564-5504  
Fax: (902) 562-4536

Mike Miller  
Branch Manager  
**Truro**  
Harris & Roome Supply  
45 Polymer Road  
Truro, NS B2N 6T8  
Tel: (902) 893-4251  
Fax: (902) 893-4806

Scott Cleveland  
Branch Manager  
**Yarmouth**  
Harris & Roome Supply  
P.O. Box 247  
6 Industry Avenue  
Yarmouth, NS B5A 4B2  
Tel: (902) 742-6771  
Fax: (902) 742-0246

### NEWFOUNDLAND

Perry Herritt  
Branch Manager  
**Corner Brook**  
Harris & Roome Supply  
P.O. Box 762  
356 O'Connell Drive  
Corner Brook, NF A2H 6G7  
Tel: (709) 632-7315  
Fax: (709) 632-2451

Gordon Smith  
Branch Manager  
**Grand Falls**  
Harris & Roome Supply  
P.O. Box 417  
4 Bayley Street  
Grand Falls-Windsor, NF A2A 2J8  
Tel: (709) 489-4161  
Fax: (709) 489-4424

Alvin Barrett  
Branch Manager  
**St. John's**  
Harris & Roome Supply  
P.O. Box 8626, Station "A"  
47 Pippy Place  
St. John's, NF A1B 3T1  
Tel: (709) 722-6161  
Fax: (709) 722-8886

Ian Allen  
Branch Manager  
**Wabush**  
Harris & Roome Supply  
P.O. Box 1049  
4 First Street  
Wabush, NF A0R 1B0  
Tel: (709) 282-3555  
Fax: (709) 282-3554



ESSENTIAL COMPONENTS. EXCEPTIONAL VALUE

# In-Stock Catalogue



[www.harrisroome.com](http://www.harrisroome.com)

Rockwell Automation

Authorised Distributor



**HARRIS & ROOME SUPPLY**



## Table of Contents



Soft Starters	1
Definite Purpose Contactors	2
IEC Contactors	3
NEMA Starters and Switches	4
Solid State Overload Relays	5
Quick Connect Starter	6
Enclosed Full-Voltage Starter	7
IEC Disconnects	8
IEC Open Style Load Switches	9
Motor Protectors	10
IEC Push Buttons - 800F	11
30mm NEMA Push Buttons	12
Push Button Enclosures	13
Industrial Relays and Timers	14
General Purpose Relays	15
Circuit Protection	16
Terminal Blocks	17
Signaling	19
Power Supplies	21
Limit Switches	22
Photoswitch Sensors	23
Inductive Proximity Sensors	25
Safety Relays and Safety Light Curtains	27
Safety Interlock Switches	28
The Small Controller Family	29
PowerFlex™ Drives	31



## SMC-3™ Smart Motor Controller

- Soft Start
- Soft Stop
- Selectable Kick Start
- Current Limit Start
- **Available from 3-85 amps. Inquire at your local branch for availability**

### Built in Features:

- Built-in by-pass.
- Electronic overload protection with adjustable trip class.
- Configurable auxiliary contacts.
- Fault diagnostics.

Current Rating	Adjustable Range	HP	Line Voltage	Control Voltage	Part Number
3	1...3	0.75...1**	200...600V AC	100...240V AC	150-C3NCD
9	3...9	3...5**	200...600V AC	100...240V AC	150-C9NCD
30	10...30	10...20**	200...600V AC	100...240V AC	150-C30NCD
37	12.3...37	15...25**	200...600V AC	100...240V AC	150-C37NCD
60	20...60	20...50**	200...600V AC	100...240V AC	150-C60NCD*

\*Note: Not in stock at all locations. Contact local distributor for more details.

\*\*At 450% current limit start setting.



## SMC™ Flex

- Soft Start / Soft Stop
- Current Limit Start
- Full Voltage Start
- Kick Start
- Dual Ramp
- Pump Control
- Smart Motor Braking
- **Available from 5-480 amps. Inquire at your local branch for availability**

### Built in Features:

- Built-in by-pass.
- Electronic overload protection with adjustable trip class.
- Configurable auxiliary contacts.
- Full metering.
- LCD display.
- Extensive fault diagnostics

Current Rating Amps	HP	Line Voltage	Control Voltage	Part Number Standard	Part Number Pump Control
54...108	60...100	200V...600V AC	100V...240V AC	150-F108NCD	150-F108NCDB
68...135	75...125	200V...600V AC	100V...240V AC	150-F135NCD*	
100...201	75...150	200V...600V AC	100V...240V AC	150-F201NCD	

\*Note: Not in stock at all locations. Contact local distributor for more details.

Consult your A-B Distributor for unit selection. Options available, see main catalogue for details.

# Definite Purpose Contactors

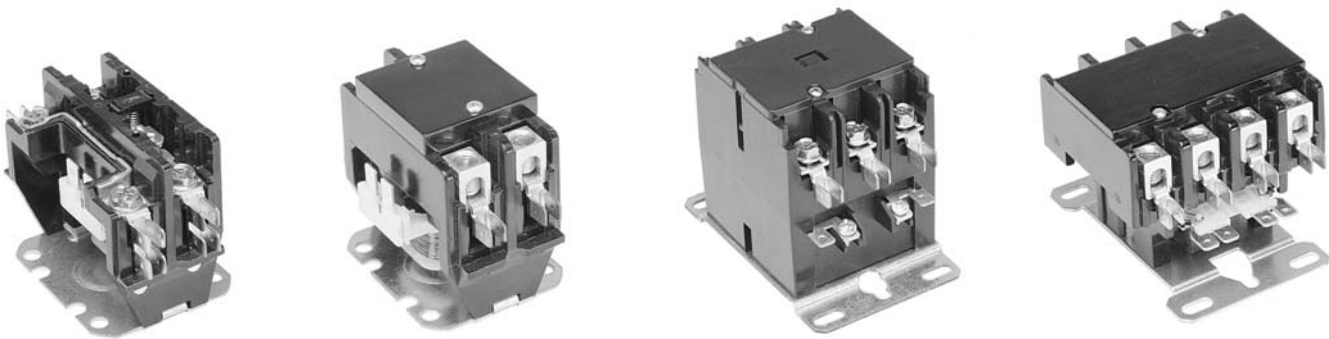

## Definite Purpose Contactors

*Product available from 25 to 90 Amps; 1 to 3 poles. Contact local branch for availability.*

Full Load Amps	Number Of Poles	Line Voltage	Resistive Amps Rating	Maximum Horsepower			Coil Voltage	Part Number
				Voltage	Single Phase	Three Phase		
25	2	600	35	240	3		120	400-DP25ND2
25	3	600	35	600		20	120	400-DP25ND3
25	4	600	35	480		15	120	400-DP25ND4
30	3	600	40	600		20	120	400-DP30ND3
40	3	600	50	600		25	208/240	400-DP40NA3
40	3	600	50	600		25	120	400-DP40ND3
50	3	600	65	600		25	120	400-DP50ND3
60	3	600	75	600		30	120	400-DP60ND3

## Auxiliary Contacts

Use With	Description	Part Number
20 to 40amp 1 to 3 pole	1 NO/1 NC	400-AB1
20 to 40amp 1 to 3 pole	SPDT	400-A1
20 to 40amp 1 to 3 pole	2 SPDT	400-A2
50 to 60 amp 3 pole	1 NO/1 NC	400-AB
50 to 60 amp 3 pole	SPDT	400-A
25 amp 4 pole	1 NO/1 NC	400-AB4
25 amp 4 pole	SPDT	400-A4

# IEC Contactors



## Bulletin 100 IEC Contactors (AC/DC COILS) Non-Enclosed

Amps	Horsepower 3-phase 3-pole AC		Part Number Non Reversing		Part Number Reversing	
	480V	575V	120V AC Coil	24V DC Coil	120V AC Coil	24V DC Coil
9	5	7.5	100-C09D10	100-C09ZJ10	104-C09D22	104-C09ZJ22
12	7.5	10	100-C12D10	100-C12ZJ10	104-C12D22	104-C12ZJ22
16	10	15	100-C16D10	100-C16ZJ10	104-C16D22	104-C16ZJ22
23	15	15	100-C23D10	100-C23ZJ10	104-C23D22	104-C23ZJ22
30	20	25	100-C30D10	100-C30ZJ10	104-C30D22	
37	25	30	100-C37D10	100-C37ZJ10		
43	30	30	100-C43D10	100-C43ZJ10		
60	40	50	100-C60D10			
72	50	60	100-C72D10*			
85	60	60	100-C85D10*			
95**	60	75	100-D95D11*			
110**	75	100	100-D110D11*			
140**	100	125	100-D140D11*			
180**	150	150	100-D180D11*			

\*Note: Not in stock at all locations. Contact local distributor for more details.

\*\* See main catalogue for Bulletin 100D accessories.

## Accessories

Description	Configuration	Side Mount Part Number	Front Mount Part Number
Auxiliary Contact (100-C)	1 N.C.	100-SA01	
	1 N.O.	100-SA10	
	1 N.O./1 N.C.	100-SA11	100-FA11
	2 N.O.	100-SA20	100-FA20
	2 N.O./2 N.C.		100-FA22
	3 N.O./1 N.C.		100-FA31
	4 N.O.		100-FA40
	2 N.C.	100-SA02	100-FA02
	4 N.C.		100-FA04
Mechanical Interlock (100-C)		100-MCA02	
Timing Module			100-FPTA30
Surge Suppressor (RC Module)	110 to 280V AC		<b>Coil Mount</b> 100-FSC280
Surge Suppressor (Diode Module)	12 to 250V DC		<b>Coil Mount</b> 100-FSD250
Surge Suppressor (Varistor Module)	56 to 136V AC		<b>Coil Mount</b>
	78 to 180V DC		100-FSV 136
	137 to 277V AC		<b>Coil Mount</b>
	181 to 350 V DC		100-FSV277
Terminal Lugs (Set of 3)		D95 to D110	100-DL110
		D140 to D180	100-DL180

# NEMA Starters and Switches



## NEMA Full Voltage Starters

NEMA Size	Amp Rating	Maximum Horsepower 600/480 V	Coil Voltage	Open Type	General Purpose Enclosure
0	18 Amps	5	120 V	509-AOD	509-AAD
1	27 Amps	10	120 V	509-BOD	509-BAD
2	45 Amps	25	120 V	509-COD	509-CAD



## NEMA Manual Starting Switches

Type of Operator	Phase	Size	Maximum Horsepower 600/480 V	General Purpose Enclosure	Type 7 & 9 Enclosure
Push Button	3	0	5	609-AAW	---
		1	10	609-BAW	---
		1	10	---	609-BEW

# Solid State Overload Relays



## E1-Plus Electronic Overload Relay

- Wide 5:1 Adjustment Range
- IEC and NEMA configurations
- Self-Powered
- Visible Trip Indication
- Ambient Temperature Compensation

	Mounts to Contactor	Current Range	Manual Reset(Class 10) Part Number	Manual/Auto-Manual Reset(Class 10,15,20,30) Part Number
<b>IEC</b>	100-C09 to C23	.1-5	193-ED1AB	193-EEAB
		.2-1	193-ED1BB	193-EEBB
		1-5	193-ED1CB	193-EECB
		3.2-1.6	193-ED1DB	193-EEDB
		5.4-27	193-ED1EB	193-EEEB
	100-C30 to C41	5.4-27	-	193-EEDD
		9-45	-	193-EEFD
100-C60 to C85	18-90	-	193-EEGE	

	Mounts to Contactor	Current Range	Manual/Auto-Manual Reset(Class 10,15,20,30) Part Number
<b>NEMA</b>	NEMA Size 00	.1-5	592-EEAT
		.2-1	592-EEBT
		1-5	592-EECT
		3.2-1.6	592-EEDT
	NEMA Size 0-2	.2-1	592-EEBC
		1-5	592-EECC
		3.2-1.6	592-EEDC
		5.4-27	592-EEEC
		9-45	592-EEFC
	NEMA Size 3	9-45	592-EEFD
		18-90	592-EEGD

## Accessories

Description	Part Number
Current Adjustment Shield	193-BC8
External Reset Adapter	193-EPM2
DIN-Rail Adapter (9-23 Amp)	193-EPB
DIN-Rail Adapter (30-41 Amp)	193-EPD

# IEC Quick Connect Starter

## Non-Reversing, Type 1 Metal Enclosure, Lift-Off Cover

- Reset Included (Factory Pre-Set Depth)
- Overload Relay Sold Separately, See Page 4
- Contactor Coil (120V AC)
- Approximate Dimensions - 11"H x 7.5"W x 5.5"D

Amps	HP		Part Number
	460 V	575 V	
9	5	7.5	109-C09G-QC
12	7.5	10	109-C12G-QC
16	10	15	109-C16G-QC
23	15	15	109-C23G-QC
30	20	25	109-C30G-QC
37	25	30	109-C37G-QC



Kit Description	Part Number
Start / Stop Push Button	198-QC-SSPB
Start / Stop Push Buttons & Pilot Light	198-QC-SSPBPL
2 Position Selector Switch	198-QC-2SS
2 Position Selector Switch & Pilot Light	198-QC-2SSPL
3 Position Selector Switch	198-QC-3SS
3 Position Selector Switch & Pilot Light	198-QC-3SSPL
Blank	198-QC-BLANK
Transformer 240 / 120	198-QC-240TX
Transformer 480 / 120	198-QC-480TX
Transformer 600 / 120	198-QC-600TX

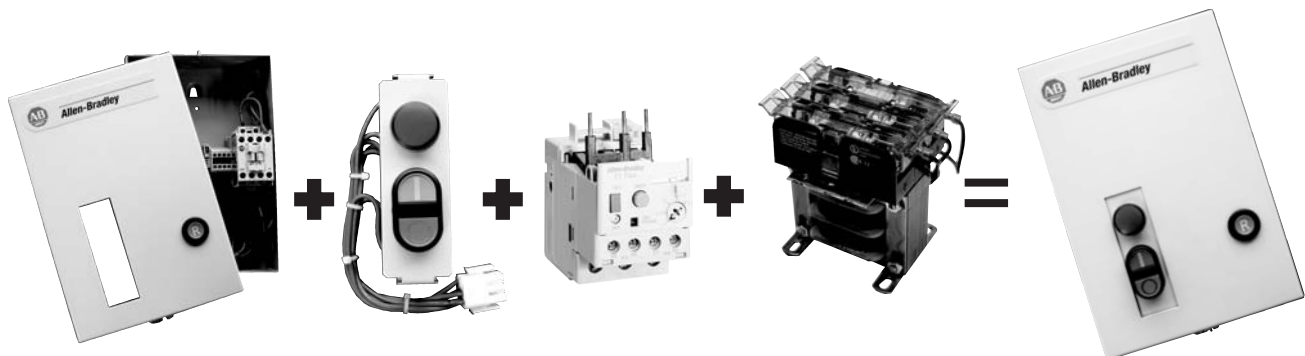

# Enclosed Full-Voltage Starter

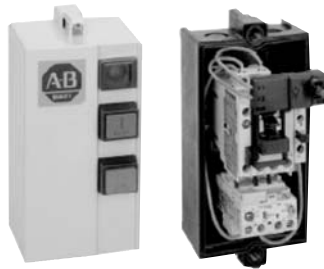

## Enclosed Full Voltage Starter Type 1, Plastic Enclosure, Lift-Off Cover

- Start/Stop and Reset Included
- Overload Relay Sold Separately, See Page 4
- Contactor Coil (120V AC)
- Approximate Dimensions - 8 5/8"H x 3 47/64"W x 5 5/32"D

Amps	HP						Part Number
	1 Phase		3 phases				
	115V	230V	200V	230V	460V	600V	
9	1/3	1	2	2	5	7 1/2	109-C09BDXXX-1-7
12	1/2	2	3	3	7 1/2	10	109-C12BDXXX-1-7
16	1	3	5	5	10	15	109-C16BDXXX-1-7
23	2	3	5	7 1/2	15	15	109-C23BDXXX-1-7

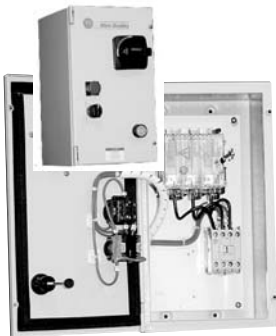

## Combination, Non Reversing Type 1, Metal Enclosure, Hinged Cover

- Pilot Light and Reset Included
- Overload Relay Sold Separately, See Page 4
- Contactor coil (120V AC)
- Fuses Sold Separately
- Approximate Dimensions - 14"H x 8"W x 8"D

Amps	HP		Part Number Start / Stop	Hand-Off Auto
	480V	575V		
9	5	7.5	112-C09-A2*	112-C09-A4*
12	7.5	10	112-C12-A2*	112-C12-A4*
23	15	15	112-C23-A2*	112-C23-A4*
30	20	25	112-C30-A2*	112-C30-A4*
37	25	30	112-C37-A2*	112-C37-A4*

\*Note: Not in stock at all locations. Contact local distributor for more details.

# IEC Disconnects

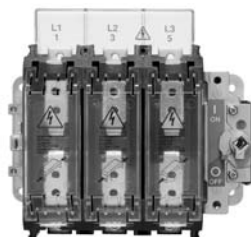

## IEC Disconnects Fused and Non-Fused

Ampere Rating (A)	Maximum HP Rating								Fuse Type	Part Number
	1-Phase		3-Phase				DC			
	120V	230V	200V	230V	460V	575V	125V	250V		
30	3/4	2	5	5	10	10	2	3	30A CLASS CC	194R-NC030P3
30	2	3	7-1/2	7-1/2	15	20	3	5	30A CLASS J	194R-NJ030P3
60	3	10	15	15	30	50	5	10	60A CLASS J	194R-NJ060P3
100	7-1/2	15	25	30	60	75	-	20	100A CLASS J	194R-NJ100P3*
200	-	25	50	60	125	150	-	40	200A CLASS J	194R-NJ200P3*
30	2	3	7-1/2	7-1/2	15	20	3	5	NON-FUSED	194R-NN030P3*
60	3	10	15	15	30	50	5	10	NON-FUSED	194R-NN060P3*
100	7-1/2	15	25	30	60	75	-	20	NON FUSED	194R-NN100P3*

\*Note: Not in stock at all locations. Contact local distributor for more details.

## Accessories

Description	Type	Used with	Part Number
Black Handle	3R, 3, 12, 4, 4X	30A & 60 A 194R's	194R-HS4
Red/Yellow Handle	3R, 3, 12, 4, 4X	30A & 60 A 194R's	194R-HS4E
Black Handle	3R, 3, 12, 4, 4X	100 - 200 A 194R's	194R-HM4*
Red/Yellow Handle	3R, 3, 12, 4, 4X	100 - 200 A 194R's	194R-HM4E*
Operating Shaft	Standard Length	30A & 60 A 194R's	194R-R1
	Extended Length	30A & 60 A 194R's	194R-R2
	Standard Length	100 - 200 A 194R's	194R-R3*
	Extended Length	100 - 200 A 194R's	194R-R4*
Terminal Shield		30A 194R	194R-LNC1
		60A 194R	194R-LNC2
		100A 194R	194R-LNC3*
		200A 194R	194R-LNC4*

\*Note: Not in stock at all locations. Contact local distributor for more details.

# IEC Open Style Load Switches

Description	Action	Max Load A	HP	Part Number
			575V	
Base Mount Switch c/w Shaft	On/Off	25	10	194E-A25-1753
		32	15	194E-A32-1753
		40	20	194E-A40-1753
		63	25	194E-A63-1753*
		80	50	194E-A80-1753*
		100	50	194E-A100-1753*
Front Mount Switch c/w Shaft	On/Off	25	10	194E-E25-1753
		32	15	194E-E32-1753
		40	20	194E-E40-1753
		63	25	194E-E63-1753*
		80	50	194E-E80-1753*
		100	50	194E-E100-1753*

\*Note: Not in stock at all locations. Contact local distributor for more details.

## Accessories

Description	Type	Use with Part Number	Part Number
Auxiliary Contact	1 N.O. / 1 N.C.	194E-A25...100	194E-A-P11
	1 N.O. / 1 N.C.	194E-E25...100	194E-E-P11
	1 N.O. / 1 N.C.L.B.	194E-A25...100	194E-A-PL11
	1 N.O. / 1 N.C.L.B.	194E-E25...100	194E-E-PL11
	2 N.O. / 2 N.C.	194E-A25...100	194E-A-P22
	2 N.O. / 2 N.C.	194E-E25...100	194E-E-P22
	1 N.O.E.B.	194E-A25...100	194E-A-PD10
	1 N.O.E.B.	194E-E25...100	194E-E-PD10
Actuator, Knob, Legend Plate	Red/Yellow, Leg.= 0-1 48mm x 48mm		194L-HE4L-175
	Red/Yellow, Leg.= ON/OFF 48mm x 48mm		194L-HE4L-175I
	Red/Yellow, Leg.= 0-1, ON/OFF 67mm x 67mm		194L-HE6N-175
Metal Shaft Ext.	110 mm...235 mm	194E-A-....	194L-G3393
	230mm...350 mm	194E-A-....	194L-G3394

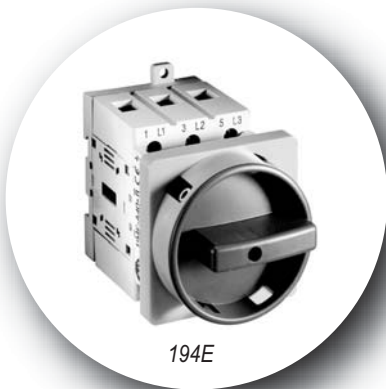

# Motor Protectors



## Motor Protectors For Use as Manual Starters Type 2 Coordination

Rated Operational Current	Typical 1-phase (HP)		Typical 3-phase (HP)			Part Number
	120V	230V	230V	460V	575V	
1.0	-	-	-	1/2	3/4	140M-C2E-B10
1.6	-	1/10	-	3/4	1	140M-C2E-B16
2.5	1/10	1/6	1/2	1-1/2	2	140M-C2E-B25
4.0	1/8	1/3	1	3	3	140M-C2E-B40
6.3	1/4	3/4	2	5	5	140M-D8E-B63
10	1/2	1-1/2	3	7-1/2	10	140M-D8E-C10
16	1	3	5	10	15	140M-D8E-C16
20	1 1/2	3	7 1/2	15	20	140M-D8E-C20

**Note:**

- The final selection of the manual starter depends on the actual motor full load current and service factor. See main catalogue for details.
- The 140M Motor Protectors provide Class 10 overload protection as well as current limiting short-circuit protection for individual motor loads. They are UL/CSA listed Manual Starters.
- Manual Self-Protected (Type E) combination starters - eliminating the requirement for additional short-circuit protection.
- Approval for motor disconnecting with the use of a lockable handle (140M-C-KN, or 140M-C-KRY).

## Accessories

Device	Description	Part Number
Auxiliary Contact	1 N.O. (Front Mount)	140M-C-AFA10
	1 N.O. / 1 N.C. (Front Mount)	140M-C-AFA11
	2 N.O. (Front Mount)	140M-C-AFA20
	1 N.O. / 1 N.C. (Right Side Mount)	140M-C-ASA11
	2 N.O. (Right Side Mount)	140M-C-ASA20
Lockable Handle	Black	140M-C-KN
	Red/Yellow	140M-C-KRY
Spacing Adapter	Type "E" application requirement	140M-C-TE

# IEC Push Buttons - 800F



## 22 mm 800F Push Buttons

Description	Part Number METAL*	Part Number PLASTIC*
Momentary Push Button Operator, Non-illuminated, Flush, Black	800FM-F2	800FP-F2
Momentary Push Button Operator, Non-illuminated, Flush, Green	800FM-F3	800FP-F3
Momentary Push Button Operator, Non-illuminated, Extended, Red	800FM-E4	800FP-E4
2-Position Selector Switch Operator, Non-illuminated, maintained	800FM-SM22	800FP-SM22
3-Position Selector Switch Operator, Non-illuminated, maintained	800FM-SM32	800FP-SM32
3-Position Selector Switch Operator, Non-illuminated, Spring return from both sides	800FM-SB32	800FP-SB32
Green Pilot Light Operator	800FM-P3	800FP-P3
Red Pilot Light Operator	800FM-P4	800FP-P4
Yellow Pilot Light Operator	800FM-P5	800FP-P5
2-Position Push-Pull, Non-illuminated, 40mm Twist-to-Release Operator, Red	800FM-MT44	800FP-MT44

\* Operator Only. Latch as well as power module or contact block required. See accessories chart below.

## Accessories

Back of Panel	Description	Part Number METAL	Part Number PLASTIC
Device	24V AC/DC Incandescent	800F-MD3C	800F-PD3C
	120V AC Incandescent	800F-MD5C	800F-PD5C
	No Bulb	800F-MD0C	800F-PD0C
Latch & Contact Block with Screw Terminations	1 N.O.	800F-MX10	800F-PX10
	1 N.C.	800F-MX01	800F-PX01
	1 N.O. - 1 N.C.	800F-MX11	800F-PX11
	2 N.O.	800F-MX20	800F-PX20
Latch		800F-ALM	800F-ALP
Contact (screw terminations)	1 N.O.		800F-X10
	1 N.C.		800F-X01
Round Legend Plate	Yellow "EMERGENCY STOP" 60 mm diameter		800F-15YE112
Legend Plate	White - Blank 30 x 50 mm		800F-35WE100
	Hole Plug Gray		800F-N8
	Full Voltage Incandescent Bulb	130V AC/DC	800F-N130
	24V AC/DC		800F-N157



Anti-rotation tab provides accurate alignment and eliminates operator and legend plate rotation. The tab is easily removed for use in panels without notches.

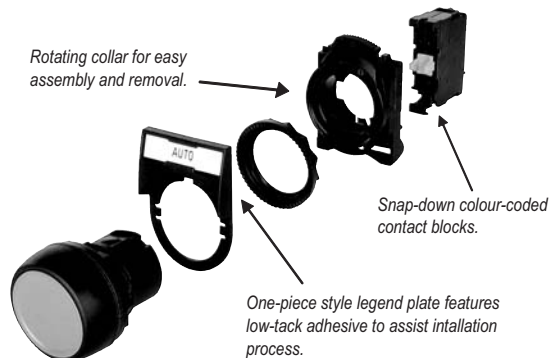

# 30mm NEMA Push Buttons

## 30mm NEMA

### Push Buttons, Selector Switches and Pilot Lights

Device	Description	Part Number No-Contacts	Part Number 1 N.O.	Part Number 1 N.C.	Part Number 1 N.O./ 1N.C.
Non Illuminated P.B.	Green, Flush Head	800T-A1	800T-A1D1		800T-A1A
	Black, Flush Head	800T-A2	800T-A2D1		800T-A2A
	Red, Flush Head	800T-A6	800T-A6D1	800T-A6D2	800T-A6A
	Red, Extended Head	800T-B6		800T-B6D2	800T-B6A
	Red, Mushroom Head.			800T-D6D2	800T-D6A
Illuminated P.B.	120V AC Xfmr., No lens				800T-PB16
	120V AC Xfmr, No lens c/w Guard				800T-PA16
	120V AC/DC No lens				800T-QB10
	24V AC/DC No lens				800T-QB24
2-Position Push-Pull Button	Red, Non-Illuminated N.C. is Late Break			800T-FX6D4 1 N.C.L.B.	800T-FX6A1 1 N.O./ 1 N.C.L.B.
					800T-FX6A5 2 N.O./ 2 N.C.L.B.
2-Position TWIST Push-Pull Button	Red, Non-Illuminated N.C. is Late Break			800T-FXT6D4 1 N.C.L.B.	800T-FXT6A1 1 N.O. / 1 N.C.L.B.
					800T-FXT6A5 2 N.O./ 2 N.C.L.B.
2-Position Selector Switch	Standard Knob, Maintained	800T-H2	800T-H2D1		800T-H2A
2-Position KEY Selector Switch	Key removed in Left Position,				800T-H31A
2-Position KEY Selector Switch	Key removed from both Positions				800T-H33A
3-Positon Selector Switch	Standard Knob, Maintained				800T-J2A
3-Position Selector Switch	Standard Knob, Spring from Left & Right				800T-J91A
		<b>Part Number No Lens</b>	<b>Part Number Red Lens</b>	<b>Part Number Green Lens</b>	<b>Part Number Amber Lens</b>
Pilot Light	120V AC XFMR	800T-P16	800T-P16R	800T-P16G	800T-P16A
Push-to-Test PL	120V AC XFMR	800T-PT16	800T-PT16R	800T-PT16G	800T-PT16A
Pilot Light	120V AC/DC Full Voltage	800T-Q10			
Pilot Light	24V AC/DC Full Voltage	800T-Q24			

## Accessories

Device	Description	Part Number
Standard Pilot Light Colour Caps	Red, Green, Amber, Blue, White	800T-N26R, -N26G, -N26A, -N26B, -N26W
Push-to-Test Colour Cap	Red, Green, Amber, Blue, White	800T-N40, -N41, -N42, -N43, -N44
Illuminated Button Extended Cap	Red, Green, Amber, Blue, White	800T-N40, -N41, -N42, -N43, -N44
Illuminated Push-Pull Colour Cap	Red, Green	800T-N159R, -N159G
Non-illuminated Push-Pull Colour Cap	Red,	800T-N160A
Protective Guard for 40mm Push-Pull	Stainless Steel	800T-N310
LED Lamp 6VAC/DC	Red, Green, Amber	800T-N318R, -N318G, -N318A
LED Lamp 120V AC	White	800T-N320W
Incandescent 24V AC/DC	Clear	800T-N157
Incandescent 130V AC/DC	Clear	800T-N169
Closing Button	Gray	800T-N1
Legend Plate	Gray, Blank	800T-X559
Sealed Switch Block	1 N.O. / 1 N.C.	800T-XAP
Contact Block	1 N.O./ 1 N.C.	800T-XA
	1 N.O.	800T-XD1
	1 N.C.	800T-XD2
	2 N.O.	800T-XA2
	2 N.C.	800T-XA4



# Push Button Enclosures



## IEC Push Button Stations *Non-Metallic Enclosure*

Description	Style	Part Number
1-Hole, 85mmH x 89mmW x 58mmD	E-Stop	800F-CPX1
2-Hole, 124mmH x 79mmW x 58mmD	Start-Stop Station	800F-CPX2
3-Hole, 155mmH, 79mmW, x 58mmD	Start-Stop & Pilot Light	800F-CPX4
1-Hole enclosure only (PG Knockouts)		800F-1PP
2-Hole enclosure only (PG Knockouts)		800F-2PP
3-Hole enclosure only (PG Knockouts)		800F-3PP



## NEMA/Eemac Enclosures *Dye Cast Metal*

Description	Style	Part Number
1 Opening surface mount	Type 4/13, Watertight/Oiltight	800T-1TZ
2 Openings surface mount	Type 4/13, Watertight/Oiltight	800T-2TZ
3 Openings surface mount	Type 4/13, Watertight/Oiltight	800T-3TZ
4 Openings surface mount	Type 4/13, Watertight/Oiltight	800T-4TZ

# Industrial Relays and Timers

## Industrial Relays

Description	Pole Configuration	Max. Contact Rating Resistive	Coil Voltage	Part Number
NEMA Convertible Cont. Relay	4 N.O. / 0 N.C.	10 Amp	120V AC	700-P400A1
	8 N.O. / 0 N.C.	10 Amp	120V AC	700-P800A1
IEC Relay	2 N.O. / 2 N.C.	10 Amp	120V AC	700-CF220D
	3 N.O. / 1 N.C.	10 Amp	120V AC	700-CF310D
	4 N.O. / 0 N.C.	10 Amp	120V AC	700-CF400D
	4 N.O. / 0 N.C.	10 Amp	24V DC	700-CF400ZJ



700-P



700-CF

## Timing Relays

Description	Pole Configuration	Max. Contact Rating Resistive	Coil Voltage	Part Number	Socket Base
Multifunction Timing Relay Timing Mode: A,D,E,B,B2,C	DPDT (11 PIN)	5 Amps	100-240V AC	700-HR52TA17	700-HN101
			100-125V DC		700-HN126
Multifunction Timing Relay Timing Mode: A,D,E,B,B2,C	DPDT (11 PIN)	5 Amps	24-48V AC	700-HR52TU24	700-HN101
			12-48V DC		700-HN126
Multifunction Timing Relay Timing Mode: A,E,B,B2,J	DPDT (8 PIN)	5 Amps	100-240V AC	700-HRS42TA17	700-HN100
			100-125V DC		700-HN125
On Delay Timer (Mode: A)	DPDT (8 PIN)	5 Amps	100-240V AC	700-HRM12TA17	700-HN100 700-HN125
On Delay 0.1 to 10 seconds	DPDT (8 PIN)	10 Amps	120V AC	700-HT12AU120	700-HN100
On Delay 0.1 to 10 minutes	DPDT (8 PIN)	10 Amps	120V AC	700-HT12CU120	700-HN125
Off Delay 0.1 to 10 seconds	DPDT (11 PIN)	10 Amps	120V AC	700-HT22AU120	700-HN101
Off Delay 0.1 to 10 minutes	DPDT (11 PIN)	10 Amps	120V AC	700-HT22CU120	700-HN126
Multifunction , 0.05 S to 10 Hrs (6 settings)	SPDT	5 Amps	24 - 240V AC 24 - 48 V DC	700-FEM3TU23	DIN Rail Mount
On Delay	1 N.O.	5 Amps	110 - 240V AC 24 V AC/DC	700-FEA1SU22	DIN Rail Mount



700-HRS



700-HRM

### Timing Modes:

(A) On Delay, (B) Repeat Cycle [OFF-start], (B2) Repeat Cycle [On-start], (C) Special ON/OFF-delay, (D) Off-delay, (E) one shot, (J) One shot

## Accessories

Description	Part Number
4 Pole Adder Deck for 700-P400A1	700-PB40
Contact Cartridge for 700-P (10 Amp)	700-CP1
Contact Cartridge for 700-P (20 Amp)	700-CPM
Surge Suppressor for 700-P (RC Circ.)	700-N24
1 N.O. / 1 N.C. Aux Cont. for 700-CF	100-SA11
2 N.O. / 0 N.C. Aux Cont. for 700-CF	100-SA20
Surge Suppressor for 700- CF relays 56 – 136V AC & 78 – 180V DC	100-FSV136

# General Purpose Relays



700-HA

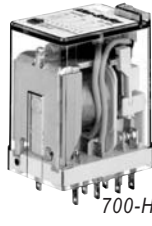

700-HC

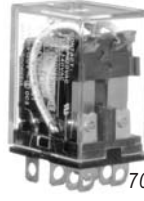

700-HF

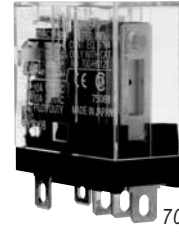

700-HK

Relay	Description		Part Numbers			
	Type	Rating	24VAC	24VDC	120VAC	Base
DP Tube Base Relay	DPDT	10 Amp	700-HA32A24	700-HA32Z24 700-HA32Z24-3-4	700-HA32A1 700-HA32A1-3 700-HA32A1-3-4	700-HN100 or 700-HN125
	3PDT	10 Amp	700-HA33A24	700-HA33Z24	700-HA33A1 700-HA33A1-3-4 700-HA33A1-4	700-HN101 or 700-HN126
DP Blade Style Relay	DPDT	15 Amp			700-HB32A1	700HN153 or 700-HN154
	3PDT	15 Amp			700-HB33A1	700-HN153 or 700-HN154
Miniature Blade Style	4PDT Gold	7 Amp (Low energy) (10V, 1 mA)		700-HC14Z24	700-HC14A1 700-HC14A1-3-4	700-HN103 or 700-HN104 or 700-HN128
	4PDT Silver	7 Amp (Low energy) (10V, 10 mA)		700-HC24Z24 700-HC24Z24-4	700-HC24A1 700-HC24A1-4	700-HN103 or 700-HN104 or 700-HN128
Miniature Solder Style Terminals	DPDT	10 Amp	700-HF32A24	700-HF32Z24	700-HF32A1 700-HF32A1-4	700-HN116
	3PDT	10 Amp			700-HF33A1	700-HN138
Power Relay	DPDT	30 Amp			700-HG42A1	
	SPDT	30 Amp			700-HG46A1	
	DPST-NO	30 Amp			700-HG47A1	
Power Relay	DPDT	25 Amp	700-HHF62A24		700-HHF62A1	
Interposing/Isolation Relay	SPDT	10 Amp	700-HK32A24	700-HK32Z24 700-HK32Z24-4	700-HK32A1 700-HK32A1-4	700-HN122
	DPDT	5 Amp		700-HK36Z24 700-HK36Z24-4	700-HK36A1 700-HK36A1-4	700-HN121
Interposing/Isolation Relay	SPDT	6 Amp	700-HLT1U24	700-HLT1Z24	700-HLT1U1	700-TBJ20G (Jumper)
Interposing/Isolation Relay Class 1 Div 2	SPDT	6 Amp	----	700-HLT1Z24-EX	700-HLT1U1-EX	----

**Note:** Suffix (-3) means Push-to-Test and Manual Override option.  
 Suffix (-4) means LED option.  
 Suffix (-3-4) means both Push-to-Test and LED options.

## Accessories

Description	Part Number
DIN Rail Mount	199-DR1
Retainer Clip for 700-HN100/HN101	700-HN157

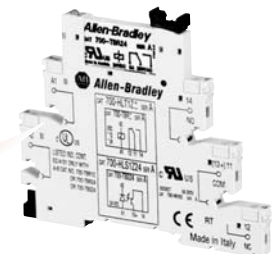

The 700-HL Terminal Block Relay  
 Truly Exceptional Value.

# Circuit Protection

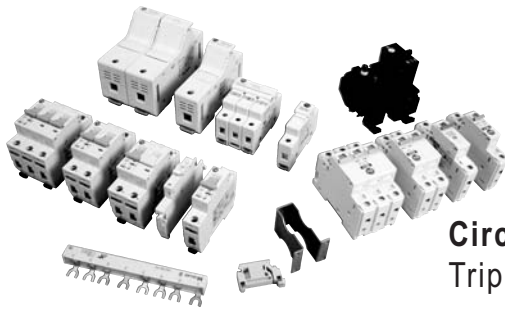

## Circuit Breakers (Supplementary Protectors) Trip Characteristic Rating "G" for Standard Duty Loads

Number of Poles	Current Rating	CB Part Number (277V AC/65V DC)	SPU Part Number * (240V AC)	SP Part Number * (277V AC/48V DC)
1	1 Amp	1492-CB1G010	1492-SPU1C010	1492-SP1C010
1	2 Amp	1492-CB1G020	1492-SPU1C020	1492-SP1C020
1	4 Amp	1492-CB1G040	1492-SPU1C040	1492-SP1C040
1	5 Amp	1492-CB1G050	1492-SPU1C050	1492-SP1C050
1	10 Amp	1492-CB1G100	1492-SPU1C100	1492-SP1C100
1	15 Amp	1492-CB1G150	1492-SPU1C150	1492-SP1C150

Number of Poles	Current Rating	CB Part Number (480V AC/65V DC)	SP Part Number * (480V/277V AC/48V DC)
2	2 Amp	1492-CB2G020	1492-SP2C020
2	3 Amp	1492-CB2G030	1492-SP2C030
2	6 Amp	1492-CB2G060	1492-SP2C060
2	15 Amp	1492-CB2G150	1492-SP2C150

Number of Poles	Current Rating	CB Part Number (480V AC/65V DC)	SP Part Number * (480V/277V AC)
3	5 Amp	1492-CB3G050	1492-SP3C050
3	10 Amp	1492-CB3G100	1492-SP3C100
3	15 Amp	1492-CB3G150	1492-SP3C150

\*These devices utilize C Curve for inductive loads with a tripping characteristic of 5...10 In, and a current range of 0.5...20 A for the SPU's, and 0.5...40 A for the SP's single pole, and 5...63 A for the SP's 2 and 3 pole.

## Circuit Breakers

Voltage Rating - 120/240V DC

Number of Poles	Current Rating	Part Number
1	60 Amp	1492-MCAA160
2	15 Amp	1492-MCAA215

## Fuse Holders

Voltage Rating - 600V AC/DC

Withstand Rating - 200kA

Number of Poles	Current Rating	Fuse Class	Part Number Without Indicator	Part Number C/W Blown Fuse Indicator
1	30 Amp	CC	1492-FB1C30	1492-FB1C30-L
2	30 Amp	CC	1492-FB2C30	1492-FB2C30-L
3	30 Amp	CC	1492-FB3C30	1492-FB3C30-L

## IEC Terminal Blocks



Voltage/Current	Description	Part Number Gray	Part Number Blue	Part Number Green	Part Number Red	End Barrier
600V AC/DC 20A	26...12 AWG	1492-J3	1492-J3-B	1492-J3-G	1492-J3-RE	1492-EBJ3
600V AC/DC 35A	22...10AWG	1492-J4	1492-J4-B	1492-J4-G	1492-J4-RE	
600V AC/DC 50A	20...8AWG	1492-J6	1492-J6-B	1492-J6-G	1492-J6-RE	
600V AC/DC 65A	16...6AWG	1492-J10	1492-J10-B	1492-J10-G	1492-J10-RE	
600V AC/DC 20A	22...14 AWG	1492-W3	---	---	---	1492-EB3
600V AC/DC 30A	22...10AWG	1492-W4	---	---	---	1492-EB10
600V AC/DC 40A	22...10AWG	1492-W6	---	---	---	
600V AC/DC 50A	22...8AWG	1492-W10	---	---	---	
300V AC/DC 20A	22...12 AWG	1492-WD4	---	---	---	1492-EBD3
300V AC/DC 20A	30...12 AWG	1492-JD3	---	---	---	1492-EBJD3

## Finger-Safe Terminal Blocks



Description	Current	Voltage Rating	Part Number	End Barrier
Single Circuit, Screw c/w Pressure plate	30 Amps	600V AC/DC	1492-H1	1492-N36
Dual Circuit, Screw c/w Pressure plate	24 Amps	600V AC/DC	1492-H2	1492-N40
Single Circuit Fusible c/w LED Blown Fuse Indicator	12 Amp	300V AC/DC	1492-H5	1492-N37
Single Circuit, Multi-rail Mount	30 Amp	600V AC/DC	1492-HM1	1492-NM36
End Anchor, Heavy Duty			1492-N23	

## QuickClamp Terminal Blocks



Description	Current	Voltage Rating	Part Number	Term. Cover
Single Circuit, Grey	25 Amp	600 V	1492-L3	1492-EBL3
Single Circuit, Grey	33 Amp	600V	1492-L4	1492-EBL4
End Anchor			1492-ERL35	

# Terminal Blocks

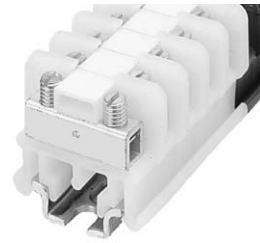

## NEMA/EEMAC Terminal Blocks

Description	Current	Voltage Rating	Part Number	End-Barrier
Tubular Screw c/w Pressure Plate	25 Amp	300V AC/DC	1492-F1	1492-N18
Tubular Screw without Pressure Plate	25 Amp	300V AC/DC	1492-F2	1492-N18
Screw Terminal with #6 Screw	25 Amp	300V AC/DC	1492-F3	1492-N18
Single Circuit Fusible c/w Neon Blown Fuse Indicator	12 Amp	300V AC/DC	1492-H4	1492-N37
Single Circuit Fusible c/w LED Blown Fuse Indicator	12 Amp	300V AC/DC	1492-H5	1492-N37
Single Circuit Fusible c/w No Blown Fuse Indicator	12 Amp	300V AC/DC	1492-H6	1492-N37
13/32"x1-1/2" fuse Block	10 Amp	600V AC/DC	1492-CE6	1492-N17
DIN Rail End Anchor (heavy duty)			1492-N23	
DIN Rail End Anchor (standard duty)			1492-EA35	
Tubular Screw c/w Pressure Plate	55 Amp	600V AC/DC	1492-CA1	1492-N16
Tubular Screw without Pressure Plate	55 Amp	600V AC/DC	1492-CA2	1492-N16
Scored AB Rail (1 meter)			1492-N1	
End Anchor Retaining Clip – light duty			1492-N2	
2 Pole Jumper (uninsulated)			1492-N3	

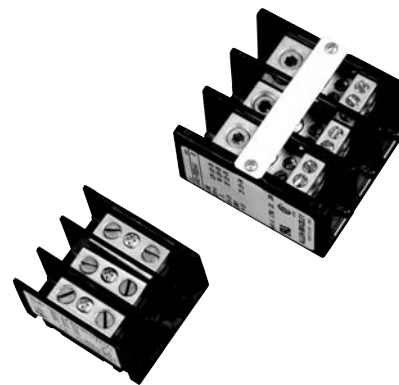

## Power Distribution Blocks

Description	Current Rating	Voltage Rating	Number of Poles	Line Pole Openings	Load Pole Openings	Part Number
1 – Line, 1 – Load	115 Amp	600V AC/DC	3	1	1	1492-PDM3111
1 – Line, 4 – Load	115 Amp	600V AC/DC	3	1	4	1492-PDM3141
1 – Line, 4 – Load	175 Amp	600V AC/DC	3	1	4	1492-PD3141
1 – Line, 6 – Load	335 Amp	600V AC/DC	3	1	6	1492-PD3163
1 – Line, 8 – Load	335 Amp	600V AC/DC	3	1	8	1492-PD3183
2 – Line, 6 – Load	350 Amp	600V AC/DC	3	2	6	1492-PD3263



## Control Tower Stack Lights

Description	Colour	Voltage	Part Number (70mm)	Part Number (50mm)
Light Module (steady incandescent)	Amber	120V AC	855T-B10DN5	
		24V AC/DC	855T-B24DN5	
	Blue	120V AC	855T-B10DN6	
		24V AC/DC	855T-B24DN6	
	Green	120V AC	855T-B10DN3	
		24V AC/DC	855T-B24DN3	855E-24DN3
	Red	120V AC	855T-B10DN4	
		24V AC/DC	855T-B24DN4	855E-24DN4
Light Module (flashing incandescent)	Amber	24V AC/DC	855T-B24FN5	
		120V AC	855T-B10FN5	855E-10FN5
	Red	120V AC	855T-B10FN4	855E-10FN4
		24V AC/DC	855T-B24FN4	
	Blue	120V AC	855T-B10FN6	
	Incandescent Lamp		120V	855T-L10
Incandescent Lamp		24V AC/DC	855T-L24	855T-L24
Light Module (steady LED)	Amber	120V AC	855T-B10TL5	
	Green	120V AC	855T-B10TL3	
	Red	120V AC	855T-B10TL4	
Light Module (no lamp)	Green			855E-00XN3
Sound Module (single tone single circuit)	Black	120V AC	855T-B10SA1	
		24V AC/DC	855T-B24SA1	
Cap	Black		855T-ABCAP	
Standard 10 cm Pole Mount			855T-BPM10	
Standard 10 cm Pole Mount c/w cap			855T-BPM10C	855E-BPM10C
Standard 25 cm Pole Mount c/w cap			855T-BPM25C	855E-BPM25C
Standard Base ,surface mount			855T-BCB	
Standard Base, surface mount c/w cap			855T-BCBC	855E-BCBC
Surface Mount			855T-BSB	
Surface Mount c/w cap			855T-BSBC	
Vertical Mount			855T-BVMC	

# Signaling

## Bulletin 855P Panel Mount Signaling Devices

• Sound output ranging from 80dB to 105dB

Description	Voltage	Part Number
Small enclosed alarm, continuous tone or pulsing	120V AC	855P-B10SE22
Small enclosed alarm, continuous tone or pulsing	120V AC	855P-B10SE22
Mid-size enclosed alarm, continuous tone or pulsing	24V AC/DC	855P-B30ME22
Large enclosed alarm, continuous, wobble or pulsing tone	120V AC	855P-B10LE22
Large enclosed alarm, continuous, wobble or pulsing tone	24V AC/DC	855P-B30LE22
Mid-size panel mount sounder with LED, red lens	24V AC/DC	855PC-B24ME422



## Bulletin 855H Industrial Horns & Beacons

Description	Voltage	Output Level	Size	Part Number
Industrial Horn	120V AC	100 dB @ 1 meter	3.4"H x 3.4"W x 3.0"D	855H-BA10AD





## Features

- Quick mounting and connecting, innovative DIN-Rail mount, Smallest in class
- Low inrush current limiting
- PFC choke
- Wide range input; auto select input
- Superior overload design (continuous current, no hiccup)  
See figure below
- Selectable operating mode (single/parallel)

## Bulletin 1606 Switched Mode Power Supplies

Rated Current	Input Voltage	Output Voltage	Output Power	Part Number
2.5A	100...240V AC, Wide Range, 160...375V DC	24V	60W	1606-XL60D
4.2A	100...120/220...240V AC, Auto Select, 220...375V DC	24...28V	100W	1606-XLP100E*
4.2A	100...120/220...240V AC, Manual Select, 220...375V DC	24...28V		1606-XLP72E*
5A	100...120/200...240V AC, Manual Select, 210...375V DC	24V	120W	1606-XL120D
5A	100...240V AC, Wide Range, 85...370V DC	5...5.5V	25W	1606-XLP25A*
4A Electronically Limited	100...120/200...240V AC, Manual Select, 240...375V DC	24V	120W	1606-XLDNET4
10A		24...28V	240W	1606-XL240E
1.3A	100...240V AC, Wide Range, 85...375V DC	24...28V	30W	1606-XLP30E*
3A		10...12V		1606-XLP30B*
2.1A		24...28V	50W	1606-XLP50E*
20A		100...120/200...240V AC, Auto Select	24...28V	480W
40A	400...500V AC Wide Range	24...28V	960W	1606-XL960E-3

\*These 1606 products are Class 1 Div 2 rated.

## Superior Overload Design Feature = Power Boost and a Constant Current

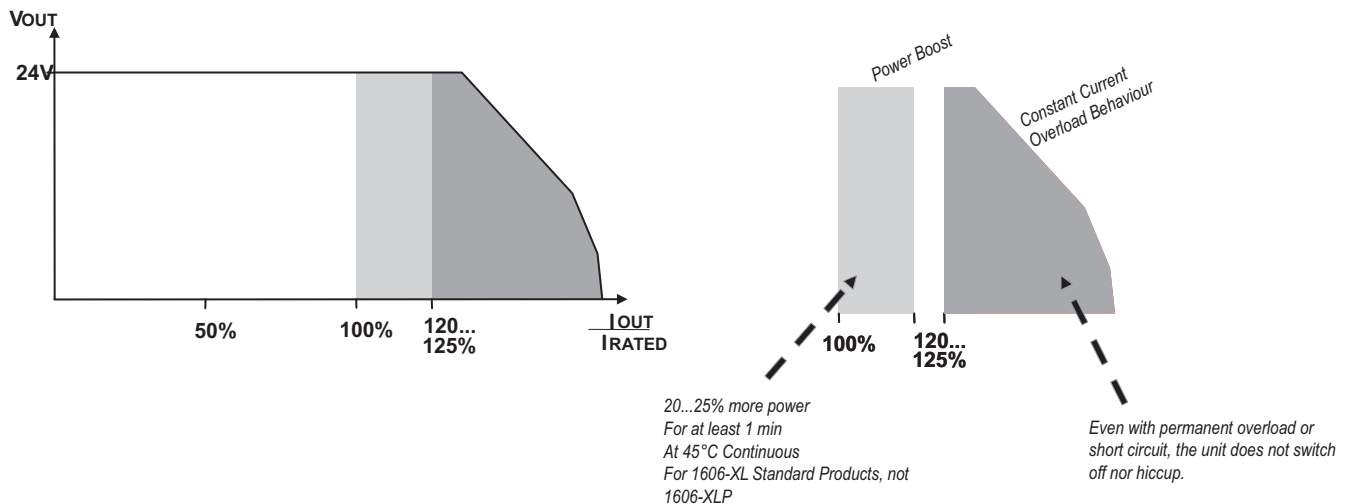

# Limit Switches - Compact Metal Body



*Rotary Arm      Wobble Stick      Top Push Roller      Top Push*

## Bulletin 802B Limit Switches

Head Type	Force to Operate	Travel to Operate	Max Travel	Travel to Reset	Mounting Style	Part Number
Rotary Arm	0.216N m (2lb in)	25°	70°	3°	Standard	802B-CSAAXSXC3
Wobble Stick	0.118N m (1.04lb in)	15°	18° (Nominal Value)	3° (Nominal Value)		802B-CSACXSX3
Top Push	11.77N (2.65lb)	1.8mm (0.071in)	5mm (0.197in)	0.2mm (0.008in)		802B-CSABXSXC3
Top Push Roller	11.77N (2.65lb)					802B-CSADXSC3

Head Type	Force to Operate	Travel to Operate	Max Travel	Travel to Reset	Mounting Style	Part Number
Top Push Panel Mount	11.8N (2.65lb)	1.5mm (0.059)	4.5mm (0.177in)	0.2mm (0.008in)	Side	802B-SPABXSX
Top Roller Panel Mount						802B-SPADXSC
Short Roller Lever	3.92N (0.88lb)	6.2±1.2mm (0.244in)	12.2mm (0.480in)	1mm (0.04in)		802B-SSAR1XSX
Top Push	2.45N - 3.43N (0.55 - 0.77lb)	0.4mm (0.016in)	5.9mm (0.232in)	0.05mm (0.002in)		802B-PSABXSX
Top Push Roller		0.5mm (0.020in)	4.1mm (0.161in)			802B-PSADXSC
Top Push Booted	8.85N (1.76lb)	2mm (0.079in)	7mm (0.276in)	0.1mm (0.004in)		802B-PSABBSX
Top Push Cross Roller Booted	4.9N (1.09lb)	1mm (0.039in)	4.5mm (0.177in)	0.12mm (0.005in)		802B-PSADBSX



*Top Push Panel Mount      Top Roller Panel Mount      Short Roller Lever*



*Top Push      Top Push Roller      Top Push Booted      Top Push Cross Roller Booted*

# Photoswitch Sensors



**Series 9000**

Description	Voltage	Sensing Range	Output Type	Output Energized	Connection Type	Part Number
Series 9000 Retroreflective	10-40V DC	51mm-9.1m	NPN/PNP	Light/Dark	4 Pin micro QD	42GRU-9000-QD
Series 9000 Retroreflective	10-55V DC 20-40V AC	51mm-9.1m	NPN/PNP	Light/Dark	2m 300V cable	42GRU-9001
Series 9000 Retroreflective	70-264VAC/DC	51mm-9.1m	SPDT Relay	Light /Dark	2m 300V cable	42GRU-9002
Series 9000 Retroreflective	70-264VAC/DC	51mm-9.1m	SPDT Relay	Light/Dark	5 pin mini QD	42GRU-9002-QD
Series 9000 Polarized Retroreflective	10-40V DC	51mm-4.9m	NPN/PNP	Light/Dark	4 pin micro QD	42GRU-9200-QD
Series 9000 Retroreflective	70-264VAC/DC	51mm-4.9m	SPDT Relay	Light/Dark	5 pin mini QD	42GRU-9202-QD



**RightSight™**

Description	Voltage	Sensing Range	Output Type	Output Energized	Connection Type	Part Number
RightSight Polarized Retroreflective	10.8-30V DC	25mm-3m	PNP	2-Complementary Light/Dark	4 pin micro QD	42EF-P2MPB-F4
RightSight Polarized Retroreflective	22-264VAC/DC	25mm-3m	NPN	Dark Operate	2m 300V cable	42EF-P2SCB-A2
RightSight Polarized Retroreflective	22-264VAC/DC	25mm-3m	NPN	Dark Operate	4 pin AC micro QD	42EF-P2SCB-G4
RightSight Standard Diffuse	10.8-30V DC	3mm-500mm	PNP	2-Complementary Light/Dark	4 pin DC micro QD	42EF-D1MPAK-F4
RightSight Background Suppression	10.8-30V DC	3mm-100mm	PNP`	2-Complementary Light/Dark	2m 300V cable	42EF-B1MPBE-A2
RightSight Background Suppression	10.8-30V DC	3mm-100mm	PNP`	2-Complementary Light/Dark	4 pin DC micro QD	42EF-B1MPBE-F4
Right Sight Background Suppression	22-264VAC/DC	3mm-100mm	NPN	Light Operate	2m 300V cable	42EF-B1RCBE-A2
Right Sight Background Suppression	22-264VAC/DC	3mm-100mm	NPN	Light Operate	4 pin AC micro QD	42EF-B1RCBE-G4
RightSight Trans Beam Source	10.8-30V DC				4 pin micro QD	42EF-E1EZB-F4
RightSight Trans Beam Receiver	10.8-30V DC	25mm-4m	PNP	2-Complementary Light/Dark Output	4 pin micro QD	42EF-R9MPBV-F4

# Photoswitch Sensors

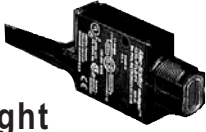

## MiniSight

Description	Voltage	Sensing Range	Output Type	Output Energized	Connection Type	Part Number
MiniSight Standard Diffuse	10.8-30V DC	1mm-380mm	NPN/PNP	Light/Dark	2m 300V cable	42KL-D1LB-A2
MiniSight Standard Diffuse	10.8-30V DC	1mm-380mm	NPN/PNP	Light/Dark	4-pin micro QD	42KL-D1LB-F4
MiniSight Trans Beam Source	10.8-30V DC	1m-30m			2m 300V cable	42KL-E1EZB-A2
MiniSight Trans Beam Receiver	10.8-30V DC	30m Max	NPN/PNP	Light/Dark	2m 300V cable	42KL-RLB-A2
MiniSight Trans Beam Source	10.8-30V DC	1m-30m			4 pin micro QD	42KL-E1EZB-F4
MiniSight Trans Beam Receiver	10.8-30V DC	30m Max	NPN/PNP	Light/Dark	4 pin micro QD	42KL-RLB-F4
MiniSight Infrared Glass Fiber	10.8-30V DC	See Glass Fiber	NPN/PNP	Light/Dark	2m 300V cable	42KL-G1LB-A2
MiniSight Infrared Glass Fiber	10.8-30V DC	See Glass Fiber	NPN/PNP	Light/Dark	4 pin micro QD	42KL-G1LB-F4
MiniSight Visible Red Plast Fiber	10.8-30V DC	See Plastic Fiber	NPN/PNP	Light/Dark	4 pin micro QD	42kl-L2LB-F4

## Accessories

Description	Nom. Sen Ref	Material	Size	Part Number
Glass Fiber Optic Cable	120mm	Brass tip/ SS Sheathing	91 mm Length	43GR-TBB25SL
Glass Fiber Optic Cable For Transmitted Beam	508mm	Brass tip (Threaded) SS Sheathing	91 mm Length	43GT-TBB25SL
Plastic Fiber Optic Cable	90mm	SS Tip/ Plastic Sheathing	2000 mm Length	43PR-NDS59FS
Plastic Fiber Optic Cable For Transmitted Beam	230mm	SS Tip (Threaded) Plastic Sheathing	2000 mm Length	43PT-NJS56FS
Reflector		Plastic back (Centre Mt)	76 mm diameter	92-39
Reflector		Plastic back (Requires adhesive)	32 mm diameter	92-47
Reflector c/w Mtg Bracket			23 x 43 mm rectangle	92-93
DC Micro style QD Cordset		4 Pin	2 m length	889D-F4AC-2
DC Micro style QD Cordset		4 Pin	5 m length	889D-F4AC-5
DC Micro style QD Cordset		4 Pin	10 m length	889D-F4AC-10
Mini Style QD Cordset		5 Pin	1.8 m yellow PVC	889N-F5AF-6F
Mini Style QD Cordset		5 Pin	3.7 m yellow PVC	889N-F5AF-12F
AC Micro Style QD Cordset		5 Pin	2 m length	889R-F4AEA-2
AC Micro Style QD Cordset		5 Pin	5 m length	889R-F4AEA-5
AC Micro Style QD Cordset		5 Pin	10 m length	889R-F4AEA-10
Swivel/Tilt Mtg. Bracket			For RightSight	60-2649
Right Angle Mtg. Bracket			For Series 9000	60-2421
Swivel/Tilt Mtg Bracket			For Series 9000	60-2439

# Inductive Proximity Sensors

## Heavy Duty - 871TM



Description	Barrel Diameter	Connection	Sensing Distance	Shielded	Output	Part Number
2-wire AC/DC, SS Face, SS Barrel	12mm	Micro QD	2 mm	Y	N.O.	871TM-B2N12-R3
	18mm	Mini QD	5 mm	Y	N.O.	871TM-B5N18-N3
		Micro QD	5 mm	Y	N.O.	871TM-B5N18-R3
3-wire DC, SS Face, SS Short Barrel	12 mm	Micro QD	2 mm	Y	N.O. PNP	871TM-DH2NP12-D4
		Micro QD	4 mm	N	N.O. PNP	871TM-DH4NP12-D4
		Micro QD	5 mm	Y	N.O. PNP	871TM-DH5NP18-D4
	18 mm	Mini QD	5 mm	Y	N.O. PNP	871TM-DH4NP12-N4
		Mini QD	8 mm	N	N.O. PNP	871TM-DH8NP18-D4
		Micro QD	20 mm	Y	N.O. PNP	871TM-M20NP30-D4
3-wire DC Extended, SS Face, threaded SS Barrel	12 mm	Micro QD	6 mm	Y	N.O. PNP	871TM-M6NP12-D4
	18mm	Micro QD	10 mm	Y	N.O. PNP	871TM-M10NP18-D4
	30mm	Micro QD	20 mm	Y	N.O. PNP	871TM-M20NP30-D4
Recommended Standard QD Cordset (-2 = 2m (6.5ft))						889D-F4AC-2



## Limit Switch - 871L and VersaCube - 871P

Description	Dimension	Connection	Sensing Distance	Shielded	Output	Part Number
Limit Switch Style AC/DC	40x40x120 mm	½" NPT Conduit	20 mm	Y	N.O. or N.C.	871L-B20E40-T2
		Micro QD	20 mm	Y	N.O. or N.C.	871L-B20E40-R3
Cube Style 2-wire AC/DC	40x40x69 mm	Mini QD	40mm	N	N.O.	871P-B40N40-N3

# Inductive Proximity Sensors



## General Purpose - 872C WorldProx

Description	Dimension	Connection	Sensing Distance	Shielded	Output	Part Number
2-wire AC, Plastic Face, Nickel-Plated Threaded Brass Barrel	12 mm Diameter	Cable 2m PVC	2 mm	Y	N.O.	872C-A4N12-A2
		Micro QD	2 mm	Y	N.O.	872C-A4N12-R3
	18 mm Diameter	Cable 2m PVC	5 mm	Y	N.O.	872C-A5N18-A2
		Micro QD	5 mm	Y	N.O.	872C-A5N18-R3
		Cable 2m PVC	10 mm	N	N.O.	872C-A10N18-A2
		Micro QD	10 mm	N	N.O.	872C-A10N18-R3
30 mm Diameter	Micro QD	10 mm	Y	N.O.	872C-A10N30-R3	
3-wire DC, Plastic Face, Nickel-Plated Threaded Brass Barrel	8 mm Diameter	Micro QD	2 mm	Y	N.O.	872C-D2NP8-D4
	12 mm Diameter	Cable 2m PVC	3 mm	Y	N.O. PNP	872C-D3NP12-E2
		Micro QD	3 mm	Y	N.O. PNP	872C-D3NP12-D4
		Micro QD	4 mm	N	N.O. PNP	872C-D4NP12-D4
	18 mm Diameter	Micro QD	5 mm	Y	N.O. PNP	872C-D5NP18-D4
		Micro QD	8 mm	N	N.O. PNP	872C-D8NP18-D4
30 mm Diameter	Micro QD	10 mm	Y	N.O. PNP	872C-D10NP30-D4	
3-wire DC, Plastic Face, <b>Short</b> Nickel-Plated Threaded Brass Barrel	12 mm Diameter	Micro QD	3 mm	Y	N.O. PNP	872C-DH3NP12-D4
3-wire DC, Plastic Face, <b>Short</b> Nickel-Plated Threaded Brass Barrel	12 mm Diameter	Micro QD	4 mm	N	N.O. PNP	872C-DH4NP12-D4

## Accessories

Description	Dimension	Wire Insulation	Part Number
4-wire DC Mini Style Cordset	1.8 m Length	Molded oil resistant PVC	889D-F4AC-2
3-wire AC Micro Style Cordset	2 m Length	Molded oil resistant PVC	889R-F3ACA-2
3-wire AC Micro Style Cordset	5 m Length	Molded oil resistant PVC	889R-F3ACA-5

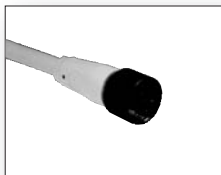

# Safety Relays & Safety Light Curtains



## Safety Relays

Relay Model	Inputs	Outputs			Operating Voltage	Part Number
		Safety N.O.	Aux. N.C.	Solid State		
MSR127T	1 N.C., 2 N.C., or L.C.	3	1	---	24V AC/DC	440R-N23126
MSR127RP	1 N.C., 2 N.C., L.C.	3	1	---	24V AC/DC	440R-N23132
MSR127RP	1 N.C., 2 N.C., L.C.	3	1	---	120V AC	440R-N23131
MSR131RTP	1 N.C., 2 N.C., or S.M. or L.C.	3	2	2 PNP	24V AC/DC	440R-C23139
MSR138DP	1 N.C., 2 N.C. or L.C.	2	---	---	24V AC/DC	440R-M23147
MSR138DP	1 N.C., 2 N.C. or L.C.	2	---	---	24V AC/DC	440R-M23088
MSR18T	1 N.C. or 2 N.C. or 1 N.C. & 1 N.O.	5	2	---	24V AC/DC & 120V AC	440R- ZBR520AZ1



## Safety Light Curtains

Description	Style	Protected Height mm (inches)	Resolution mm (inches)	Number of Beams	Part Number	Optional Weld Shield	Dimension "L" mm(inches)
Light Curtain Pair	GuardShield	480 (18.9)	30 (1.18)	24	440L-P4K0480YD	440L-AGWS0480	495.3 (19.50)
		640 (25.2)	30 (1.18)	32	440L-P4K0640YD	440L-AGWS0640	655.3 (25.80)
		800 (31.5)	30 (1.18)	40	440L-P4K0800YD	440L-AGWS0800	815.3 (32.10)
		960 (37.8)	30 (1.18)	48	440L-P4K0960YD	440L-AGWS0960	975.4 (38.40)
Cord Sets (2 Required)	For Receiver - Straight	10m (32 ft)			889D-F8AB-10	---	---
	For Receiver - Right Angle				889D-R8AB-10	---	---
	For Transmitter - Straight				889D-F4AC-10	---	---
	For Transmitter - Right Angle				889D-R4AC-10	---	---
Safety Relay	3 N.O. Safety & 1 N.C. aux.	24V AC/DC			440R-N23132	---	---
Mounting Brackets	Aluminum middle mounting Bracket for vibratory applications				440L-AF6108	---	---
	Steel L-Shaped end cap, Package of 4				440L-AF6101	---	---
Power Supply	120 - 240V AC to 24V DC				1606-XLP72E	---	---

### GuardShield Light Curtain Weld Shield

Locate the precut Velcro strips adjacent to the inside curved edge of each side of the weld shield.

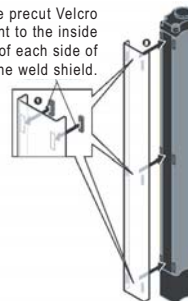

# Safety Interlock Switches



Description	Model	Safety Contacts	Notes	Part Number
Tongue operated interlock switch	Trojan 6 Standard, BBM	2 N.C. 2 N.O. Aux.	No Actuator	440K-T11416
Tongue operated interlock switch	Trojan 6 Metal Guard, BBM	2 N.C. 2 N.O. Aux	No Actuator	440K-T11433
Tongue operated interlock switch	Trojan 6 Metal Guard, MBB	2 N.C. 2 N.O. Aux	No Actuator	440K-T11461
Narrow Tongue operated Interlock switch	MT-GD2	2 N.C. 2 N.O. Aux.	No Actuator	440K-MT55086
Tongue operated interlock switch	Cadet Standard	1 N.C. & 1 N.O.	No Actuator	440K-E33014
Tongue operated interlock switch	Cadet Standard	2 N.C.	No Actuator	440K-E33047
Tongue operated interlock switch	Cadet 3 c/w GD2 Metal Alignment	2 N.C. & 1 N.O. Aux.	Semi-flexible	440K-C21074
Cable Actuated Emergency Stop Switch	Lifeline 4	3 N.C. Safety & 1 N.O. Aux.		440E-L13043
Lifeline Rope Tensioner	LRTS	Installation Kit – 15 meters		440E-A13081
Lifeline Rope Tensioner	LRTS	Installation Kit – 30 meters		440E-A13083
Non contact Switches	Sipha Sensor	1 N.O. / 1 N.C.	10 m Cable	440N-S32017
Non contact Switches	Sipha Sensor	1 N.O. / 1 N.C. 1 N.C. Aux.	3 m Cable	440N-S32022
Sipha Relay	Sipha	2 N.O. / 1 N.C. Aux.	24V AC/DC 120/230V AC	440N-S32021
Ferrocode Control Unit	Ferrocode	2 N.O. & 1 N.C. Aux	120/230V AC	440N-C02070
Switch & Actuator	Ferrocode	1 N.C. & 1 N.O.	24V AC/DC	440N-C02078

## Accessories

Device	Description	Part Number
Standard Actuator Key	GD2 Model Only	440G-A27011
Fully-Flexible Actuator Key		440G-A27143
Alignment Guide & Semi-Flexible Actuator	Use with Trojan	440K-A11144
Alignment Guide & Semi-Flexible Actuator	Use with Elf/Cadet	440K-A21030
Alignment Guide & Fully-Flexible Actuator		440K-A27010

# The Small Controller Family

## Pico Controller

Description	Specification	Part Number
(8) 120 / 240V AC Input, (4) Relay Output, AC Line, RTC & Display	12 I/O PICO Controller with RTC, AC	1760-L12AWA
(12) 120/240V AC Input, (6) Relay Output, AC Line, RTC & Display	18 I/O PICO Controller with RTC, AC	1760-L18AWA



- On-Board LCD & Keypad for Programming
- 12V DC Controller available
- Real Time Clock
- Lowest Price Programmable Logic Controller (PLC)

## Pico GFX Controller

Description	Part Number
Display Unit with Buttons	1760-DUB
Processor for Networks (Pico-Link)	1760-LDFC
Standard Processor	1760-LDF
GFX 12 DC IN 4 Relay AI	1760-IB12XOW4IF
GFX 12 DC IN 4 Relay AI/O	1760-IB12XOW4IOF
GFX 12 DC IN 4 DC Out AI	1760-IB12XOB4IF
GFX 12 DC IN 4 DC Out AIO	1760-IB12XOB4IOF
5M Serial link cbl	1760-CBL-5M
GFX memory module	1760-MM3
Pico-Link cbl .3m	1760-CBL-INT01
Pico-Link cbl .8m	1760-CBL-INT03
Pico-Link cbl 1.5m	1760-CBL-INT05
PicoSoft Pro Software	1760-PICOSOFTPRO
PicoSoft Pro Software and Programming Cable	1760-PICOPROPC02



- Multi-Function Display
- Analog & Digital I/O
- Expandable to 272 Points
- Ladder Logic Programming

## MicroLogix 1000

Description	Specification	Part Number
(6) 24V DC Input, (4) Relay Output, AC Line	10 I/O MicroLogix 1000	1761-L10BWA
(6) 24V DC Input, (4) Relay Output, DC Line	10 I/O MicroLogix 1000	1761-L10BWB
(10) 120V AC Input, (6) Relay Output, AC Line	16 I/O MicroLogix 1000	1761-L16AWA
(10) 24V DC Input, (4) DC Mosfet & (2) Relay Outputs, DC Line	16 I/O MicroLogix 1000	1761-L16BBB
(10) 24V DC Input (6) Relay Output, AC Line	16 I/O MicroLogix 1000	1761-L16BWA
(10) 24V DC Input, (6) Relay Output, DC Line	16 I/O MicroLogix 1000	1761-L16BWB
(20) 24V DC Input, (12) Relay Output, AC Line	32 I/O MicroLogix 1000	1761-L32BWA
(20) 24V DC Input, (12) Relay Output, DC Line	32 I/O MicroLogix 1000	1761-L32BWB



- Peer to Peer Messaging Capability
- Expandable Analog I/O
- Built-in EEPROM Memory
- RTU Slave Protocol Support

# The Small Controller Family

## MicroLogix 1200

Description	Specification	Part Number
24 PT. DC Input, DC Line	MicroLogix 1200	1762-L24BWA
24 PT. AC Input, DC Line	MicroLogix 1200	1762-L24AWA
24 PT. DC Input, DC Line	MicroLogix 1200	1762-L24BXB
24 PT. AC Input, DC Line	MicroLogix 1200	1762-L40AWA
40 PT. DC Input DC Line	MicroLogix 1200	1762-L40BWA
Memory Module	For All Models	1762-MM1
Memory Module with RTC	For All Models	1762-MM1RTC
8 Point 120 VAC	Input Module	1762-IA8
16 Point 24 VDC Sink/Source	Input Module	1762-IQ16
8 Point VAC/VDC Relay	Input Module	1762-IQ8
16 Point VAC/VDC Relay	Output Module	1762-OW16
8 Point VAC/VDC Relay	Output Module	1762-OW8
4 Channel	Analog Combo Module	1762-IF20F2
4 Channel Current/Voltage	Analog Input Module	1762-IF4
4 Channel	Analog Input Module	1762-OF4
Real Time Clock	For All Models	1762-RTC
8 Point VDC	Output Module	1762-OA8
8 Point VDC	Output Module	1762-OB8
16 Point VDC	Output Module	1762-OB16



- Programming/HMI Interface Port
- Expansion I/O
- Increased Application Flexibility
- RTU with Modem and Local HMI

## MicroLogix 1500

Description	Specification	Part Number
MicroLogix 1500 with additional RS-232	Enhanced Processor Unit	1764-LRP
MicroLogix 1500	Standard Processor Unit	1764-LSP
Memory Module	ML 1500 Processor	1764-MM1
Memory Module with Real Time Clock		1764-MM1 RTC
12 AC Inputs/ 12 Relay Outputs/ AC Power	ML 1500 Base	1764-24AWA
12 DC Inputs/ 12 Relay Outputs/ AC Power	ML 1500 Base	1764-24BWA
16 DC Inputs/ 6 Relay, 6 DC FET Outputs/ 24V DC Power	ML 1500 Base	1764-28BWB



- Expandable I/O Networks
- Large Non-Volatile Memory
- High Speed I/O Functions
- Data-Logging Memory

## PowerFlex 4 & 40 Variable Frequency Drive

Voltage Rating	HP Rating	Part Number PowerFlex 4	Part Number PowerFlex 40
120V 50/60Hz, 1-phase, no filter	0.25	22A-V1P5N104	---
	0.5	22A-V2P3N104	22B-V2P3N104
	1	22A-V4P5N104	22B-V5P0N104
	1.5	22A-V6P0N104	22B-V6P0N104
240V 50/60Hz, 1-phase, No Brake no filter	0.25	22A-A1P4N103	---
	0.5	22A-A2P1N103	---
	1	22A-A3P6N103	---
	2	22A-A6P8N103	---
	3	22A-A9P6N103	---
240V 50/60Hz, 1-phase, No Brake with filter	0.25	22A-A1P4N113	---
	0.5	22A-A2P1N113	---
	1	22A-A3P6N113	---
	2	22A-A6P8N113	---
	3	22A-A9P6N113	---
240V 50/60Hz, 1-phase, with filter	0.25	22A-A1P5N114	---
	0.5	22A-A2P3N114	22B-A2P3N114
	1	22A-A4P5N114	22B-A5P0N114
	2	22A-A8P0N114	22B-A8P0N114
	3	---	22B-A012N114
240V 50/60Hz, 1-phase, no filter	0.25	22A-A1P5N104	---
	0.5	22A-A2P3N104	22B-A2P3N104
	1	22A-A4P5N104	22B-A5P0N104
	2	22A-A8P0N104	22B-A8P0N104
	3	---	22B-A012N104
240V 50/60Hz, 3-phase, no filter	0.25	22A-B1P5N104	---
	0.5	22A-B2P3N104	22B-B2P3N104
	1	22A-B4P5N104	22B-B5P0N104
	2	22A-B8P0N104	22B-B8P0N104
	3	22A-B012N104	22B-B012N104
	5	22A-B017N104	22B-B017N104
	7.5	---	22B-B024N104
	10	---	22B-B033N104
	15	---	---
480V 50/60Hz, 3-phase, no filter	0.5	22A-D1P4N104	22B-D1P4N104
	1	22A-D2P3N104	22B-D2P3N104
	2	22A-D4P0N104	22B-D4P0N104
	3	22A-D6P0N104	22B-D6P0N104
	5	22A-D8P7N104	22B-D010N104
	7.5	---	22B-D012N104
	10	---	22B-D017N104
	15	---	22B-D024N104
600V 60Hz, 3-phase, no filter	1	---	22B-E1P7N104
	2	---	22B-E3P0N104
	3	---	22B-E4P2N104
	5	---	22B-E6P6N104
	7.5	---	22B-E9P9N104
	10	---	22B-E012N104
	15	---	22B-E019N104



PowerFlex 4



PowerFlex 40

## Accessories

Description	Part Number
LCD Display, Remote Panel Mount Digital Keypad	22-HIM-C2S
LCD Display, Remote Hand Held Digital Keypad	22-HIM-A3
Bezel Kit for Panel Mount LCD Display	22-HIM-B1
DSI HIM to RJ45 cable - 2.9 meter	22-HIM-H30
DSI HIM to RJ45 cable - 1 meter	22-HIM-H10
Serial Converter Module	22-SCM-232
DSI Cable - 2 meter, male to male RJ45	22-RJ45CBL-C20
DeviceNet Comm Module	22-COMM-D
Ethernet Comm Module	22-COMM-E
Profibus Comm Module	22-COMM-P
Comm. Adaptor Cover - Frame B	22B-CBC
Comm. Adaptor Cover - Frame C	22B-CCC
NEMA 1 (IP30) Conduit Box Kit - Frame A	22-JBAA
NEMA 1 (IP30) Conduit Box Kit - Frame B	22-JBAB
NEMA 1 (IP30) Conduit Box Kit - Frame C	22-JBAA
PF40 NEMA 1 (IP30) Conduit/Comm. Option Box Kit - Frame C	22-JBCB
PF40 NEMA 1 (IP30) Conduit/Comm. Option Box Kit - Frame B	22-JBCC

# PowerFlex Drives

## PowerFlex 70 Variable Frequency Drive

Voltage Rating	HP Rating	Part Number
240V 3-phase Input	0.5	20AB2P2A0AYNNNC
	1	20AB4P2A0AYNNNC
	2	20AB6P8A0AYNNNC
	3	20AB9P6A0AYNNNC
	5	20AB015A0AYNANC
	7.5	20AB022A0AYNANC
	10	20AB028A0AYNANC
	15	20AB042A0AYNANC
	20	20AB054A0AYNANC
480V 3-phase Input	25	20AB070A0AYNANC
	0.5	20AD1P1A0AYNNNC
	1	20AD2P1A0AYNNNC
	2	20AD3P4A0AYNNNC
	3	20AD5P0A0AYNNNC
	5	20AD8P0A0AYNNNC
	7.5	20AD011A0AYNANC
	10	20AD014A0AYNANC
	15	20AD022A0AYNANC
	20	20AD027A0AYNANC
	25	20AD034A0AYNANC
	30	20AD040A0AYNANC
	40	20AD052A0AYNANC
50	20AD065A0AYNANC	
600V 3-phase Input	0.5	20AE0P9A0AYNNNC
	1	20AE1P7A0AYNNNC
	2	20AE2P7A0AYNNNC
	3	20AE3P9A0AYNNNC
	5	20AE6P1A0AYNNNC
	7.5	20AE9P0A0AYNNNC
	10	20AE011A0AYNNNC
	15	20AE017A0AYNNNC
	20	20AE022A0AYNNNC
	25	20AE027A0AYNNNC*
	30	20AE032A0AYNNNC*
	40	20AE041A0AYNNNC*
	50	20AE052A0AYNNNC*



PowerFlex 70

\*Note - Not available until second quarter 2005.

## Accessories

Description	Part Number
Blank Plate HIM	20-HIM-A0
LCD Display HIM, Digital Speed	20-HIM-A2
LCD Display HIM with Full Numeric Keypad	20-HIM-A3
LCD Display HIM with Analog Pot	20-HIM-A4
LCD Display HIM, Programmer Only	20-HIM-A5
Bezel Kit for LCD HIMs, NEMA 1	20-HIM-B1
Remote LCD HIM with Full Numeric Keypad	20-HIM-C3S
Remote LCD HIM, Programmer Only	20-HIM-C5S
Remote HIM Cable	20-HIM-H10
Remote I/O Comm. Module	20-COMM-R
DeviceNet Comm. Module	20-COMM-D
ControlNet Comm. Module	20-COMM-C
Ethernet I/P Comm. Module	20-COMM-E
Profibus Comm. Module	20-COMM-P
Serial Converter Module	1203-SSS
DriveGuard Safe-Off Board	20A-DG01
5V/12V Encoder Option Kit	20A-ENC-1
115V Control I/O Kit	AK-M9-115VAC-1